



8 X 1"1/4



U2 FASTENERS™
870 TUNGSTEN ST
THUNDER BAY, ON
P7B 6J3 CANADA

4,000 PCS
Approx. 19 lbs.



TIGHT STAR RECESS
NO STRIPPING



TAKES A T-15 U-BIT



WASHER HEAD

CABINETS AND MORE



L- SHAPED CUTTING
TEETH

INTERIOR / EXTERIOR USE



TAPPER POINT
NO PREDRILLING

PATENT PENDING
MADE IN TAIWAN

190312 LOT 120319

C08101250B

CAP SCREW



8 X 1"1/4



U2 FASTENERS™
870 TUNGSTEN ST
THUNDER BAY, ON
P7B 6J3 CANADA

4,000 PCS
Approx. 19 lbs.



TIGHT STAR RECESS
NO STRIPPING



TAKES A T-15 U-BIT



WASHER HEAD

CABINETS AND MORE



L- SHAPED CUTTING
TEETH

INTERIOR / EXTERIOR USE



TAPPER POINT
NO PREDRILLING

PATENT PENDING
MADE IN TAIWAN

190312 LOT 120319

C08101250B

CAP SCREW





8 X 1"1/2



U2 FASTENERS™
870 TUNGSTEN ST
THUNDER BAY, ON
P7B 6J3 CANADA

3,000 PCS
Approx. 17 lbs.



TIGHT STAR RECESS
NO STRIPPING



TAKES A T-15 U-BIT



WASHER HEAD

CABINETS AND MORE



L- SHAPED CUTTING
TEETH

INTERIOR / EXTERIOR USE



TAPPER POINT
NO PREDRILLING

PATENT PENDING
MADE IN TAIWAN

190312 LOT 120319

C08101500B

CAP SCREW



8 X 1"1/2



U2 FASTENERS™
870 TUNGSTEN ST
THUNDER BAY, ON
P7B 6J3 CANADA

3,000 PCS
Approx. 17 lbs.



TIGHT STAR RECESS
NO STRIPPING



TAKES A T-15 U-BIT



WASHER HEAD

CABINETS AND MORE



L- SHAPED CUTTING
TEETH

INTERIOR / EXTERIOR USE



TAPPER POINT
NO PREDRILLING

PATENT PENDING
MADE IN TAIWAN

190312 LOT 120319

C08101500B

CAP SCREW





8 X 1"3/4



U2 FASTENERS™
870 TUNGSTEN ST
THUNDER BAY, ON
P7B 6J3 CANADA

2,000 PCS
Approx. 13 lbs.



TIGHT STAR RECESS
NO STRIPPING



TAKES A T-15 U-BIT



WASHER HEAD

CABINETS AND MORE



L-SHAPED CUTTING
TEETH

INTERIOR / EXTERIOR USE



TAPPER POINT
NO PREDRILLING

PATENT PENDING
MADE IN TAIWAN

190312 LOT 120319

C08101750B

CAP SCREW



8 X 1"3/4



U2 FASTENERS™
870 TUNGSTEN ST
THUNDER BAY, ON
P7B 6J3 CANADA

2,000 PCS
Approx. 13 lbs.



TIGHT STAR RECESS
NO STRIPPING



TAKES A T-15 U-BIT



WASHER HEAD

CABINETS AND MORE



L-SHAPED CUTTING
TEETH

INTERIOR / EXTERIOR USE



TAPPER POINT
NO PREDRILLING

PATENT PENDING
MADE IN TAIWAN

190312 LOT 120319

C08101750B

CAP SCREW





8 X 2"



U2 FASTENERS™
870 TUNGSTEN ST
THUNDER BAY, ON
P7B 6J3 CANADA

2,000 PCS
Approx. 14 lbs.



*TIGHT STAR RECESS
NO STRIPPING*



TAKES A T-15 U-BIT



WASHER HEAD

CABINETS AND MORE



*L- SHAPED CUTTING
TEETH*

INTERIOR / EXTERIOR USE



*TAPPER POINT
NO PREDRILLING*

**PATENT PENDING
MADE IN TAIWAN**

190312 LOT 120319

C08102000B

CAP SCREW



8 X 2"



U2 FASTENERS™
870 TUNGSTEN ST
THUNDER BAY, ON
P7B 6J3 CANADA

2,000 PCS
Approx. 14 lbs.



*TIGHT STAR RECESS
NO STRIPPING*



TAKES A T-15 U-BIT



WASHER HEAD

CABINETS AND MORE



*L- SHAPED CUTTING
TEETH*

INTERIOR / EXTERIOR USE



*TAPPER POINT
NO PREDRILLING*

**PATENT PENDING
MADE IN TAIWAN**

190312 LOT 120319

C08102000B

CAP SCREW





8 X 2"1/2



U2 FASTENERS™
870 TUNGSTEN ST
THUNDER BAY, ON
P7B 6J3 CANADA

1,500 PCS
Approx. 13 lbs.



TIGHT STAR RECESS
NO STRIPPING



TAKES A T-15 U-BIT



WASHER HEAD

CABINETS AND MORE



L- SHAPED CUTTING
TEETH

INTERIOR / EXTERIOR USE



TAPPER POINT
NO PREDRILLING

PATENT PENDING
MADE IN TAIWAN

190312 LOT 120319

C08102500B

CAP SCREW



8 X 2"1/2



U2 FASTENERS™
870 TUNGSTEN ST
THUNDER BAY, ON
P7B 6J3 CANADA

1,500 PCS
Approx. 13 lbs.



TIGHT STAR RECESS
NO STRIPPING



TAKES A T-15 U-BIT



WASHER HEAD

CABINETS AND MORE



L- SHAPED CUTTING
TEETH

INTERIOR / EXTERIOR USE



TAPPER POINT
NO PREDRILLING

PATENT PENDING
MADE IN TAIWAN

190312 LOT 120319

C08102500B

CAP SCREW





8 X 2"3/4



U2 FASTENERS™
870 TUNGSTEN ST
THUNDER BAY, ON
P7B 6J3 CANADA

1,200 PCS
Approx. 14 lbs.



TIGHT STAR RECESS
NO STRIPPING



TAKES A T-15 U-BIT



WASHER HEAD

CABINETS AND MORE



L-SHAPED CUTTING
TEETH

INTERIOR / EXTERIOR USE



TAPPER POINT
NO PREDRILLING

PATENT PENDING
MADE IN TAIWAN

190312 LOT 120319

C08102750B

CAP SCREW



8 X 2"3/4



U2 FASTENERS™
870 TUNGSTEN ST
THUNDER BAY, ON
P7B 6J3 CANADA

1,200 PCS
Approx. 14 lbs.



TIGHT STAR RECESS
NO STRIPPING



TAKES A T-15 U-BIT



WASHER HEAD

CABINETS AND MORE



L-SHAPED CUTTING
TEETH

INTERIOR / EXTERIOR USE



TAPPER POINT
NO PREDRILLING

PATENT PENDING
MADE IN TAIWAN

190312 LOT 120319

C08102750B

CAP SCREW





8 X 3"1/8



U2 FASTENERS™
870 TUNGSTEN ST
THUNDER BAY, ON
P7B 6J3 CANADA

1,000 PCS
Approx. 10 lbs.



TIGHT STAR RECESS
NO STRIPPING



TAKES A T-15 U-BIT



WASHER HEAD

CABINETS AND MORE



L- SHAPED CUTTING
TEETH

INTERIOR / EXTERIOR USE



TAPPER POINT
NO PREDRILLING

PATENT PENDING
MADE IN TAIWAN

190312 LOT 120319

C08103125B

CAP SCREW



8 X 3"1/8



U2 FASTENERS™
870 TUNGSTEN ST
THUNDER BAY, ON
P7B 6J3 CANADA

1,000 PCS
Approx. 10 lbs.



TIGHT STAR RECESS
NO STRIPPING



TAKES A T-15 U-BIT



WASHER HEAD

CABINETS AND MORE



L- SHAPED CUTTING
TEETH

INTERIOR / EXTERIOR USE



TAPPER POINT
NO PREDRILLING

PATENT PENDING
MADE IN TAIWAN

190312 LOT 120319

C08103125B

CAP SCREW





8 X 2"



U2 FASTENERS™
870 TUNGSTEN ST
THUNDER BAY, ON
P7B 6J3 CANADA

4,500 PCS
Approx. 25 lbs.



TIGHT STAR RECESS
NO STRIPPING



TAKES A T- 10 U-BIT



CUTTING NIBS

TRIM AND FINISHING



L- SHAPED CUTTING
TEETH

INTERIOR / EXTERIOR USE



TAPPER POINT
NO PREDRILLING

PATENT PENDING
MADE IN TAIWAN

190312 LOT 120319

E08102000B

WHITE-FINE SCREW



8 X 2"



U2 FASTENERS™
870 TUNGSTEN ST
THUNDER BAY, ON
P7B 6J3 CANADA

4,500 PCS
Approx. 25 lbs.



TIGHT STAR RECESS
NO STRIPPING



TAKES A T- 10 U-BIT



CUTTING NIBS

TRIM AND FINISHING



L- SHAPED CUTTING
TEETH

INTERIOR / EXTERIOR USE



TAPPER POINT
NO PREDRILLING

PATENT PENDING
MADE IN TAIWAN

190312 LOT 120319

E08102000B

WHITE-FINE SCREW





8 X 2"1/2



U2 FASTENERS™
870 TUNGSTEN ST
THUNDER BAY, ON
P7B 6J3 CANADA

3,500 PCS
Approx. 24 lbs.



TIGHT STAR RECESS
NO STRIPPING



TAKES A T- 10 U-BIT



CUTTING NIBS

TRIM AND FINISHING



L- SHAPED CUTTING
TEETH

INTERIOR / EXTERIOR USE



TAPPER POINT
NO PREDRILLING

PATENT PENDING
MADE IN TAIWAN

190312 LOT 120319

E08102500B

WHITE-FINE SCREW



8 X 2"1/2



U2 FASTENERS™
870 TUNGSTEN ST
THUNDER BAY, ON
P7B 6J3 CANADA

3,500 PCS
Approx. 24 lbs.



TIGHT STAR RECESS
NO STRIPPING



TAKES A T- 10 U-BIT



CUTTING NIBS

TRIM AND FINISHING



L- SHAPED CUTTING
TEETH

INTERIOR / EXTERIOR USE



TAPPER POINT
NO PREDRILLING

PATENT PENDING
MADE IN TAIWAN

190312 LOT 120319

E08102500B

WHITE-FINE SCREW





8 X 2"3/4



U2 FASTENERS™
870 TUNGSTEN ST
THUNDER BAY, ON
P7B 6J3 CANADA

3,000 PCS
Approx. 23 lbs.



TIGHT STAR RECESS
NO STRIPPING



TAKES A T- 10 U-BIT



CUTTING NIBS

TRIM AND FINISHING



L- SHAPED CUTTING
TEETH

INTERIOR / EXTERIOR USE



TAPPER POINT
NO PREDRILLING

PATENT PENDING
MADE IN TAIWAN

190312 LOT 120319

E08102750B

WHITE-FINE SCREW

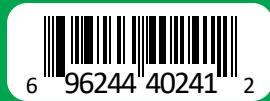

8 X 2"3/4



U2 FASTENERS™
870 TUNGSTEN ST
THUNDER BAY, ON
P7B 6J3 CANADA

3,000 PCS
Approx. 23 lbs.



TIGHT STAR RECESS
NO STRIPPING



TAKES A T- 10 U-BIT



CUTTING NIBS

TRIM AND FINISHING



L- SHAPED CUTTING
TEETH

INTERIOR / EXTERIOR USE



TAPPER POINT
NO PREDRILLING

PATENT PENDING
MADE IN TAIWAN

190312 LOT 120319

E08102750B

WHITE-FINE SCREW





8 X 3"1/8



U2 FASTENERS™
870 TUNGSTEN ST
THUNDER BAY, ON
P7B 6J3 CANADA

2,000 PCS
Approx. 17 lbs.



TIGHT STAR RECESS
NO STRIPPING



TAKES A T- 10 U-BIT

CUTTING NIBS



TRIM AND FINISHING

L- SHAPED CUTTING
TEETH



INTERIOR / EXTERIOR USE

TAPPER POINT
NO PREDRILLING



PATENT PENDING
MADE IN TAIWAN

190312 LOT 120319

E08103125B

WHITE-FINE SCREW

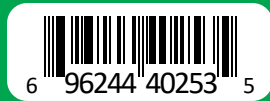

8 X 3"1/8



U2 FASTENERS™
870 TUNGSTEN ST
THUNDER BAY, ON
P7B 6J3 CANADA

2,000 PCS
Approx. 17 lbs.



TIGHT STAR RECESS
NO STRIPPING



TAKES A T- 10 U-BIT

CUTTING NIBS



TRIM AND FINISHING

L- SHAPED CUTTING
TEETH



INTERIOR / EXTERIOR USE

TAPPER POINT
NO PREDRILLING



PATENT PENDING
MADE IN TAIWAN

190312 LOT 120319

E08103125B

WHITE-FINE SCREW





8 X 1"1/4



U2 FASTENERS™
870 TUNGSTEN ST
THUNDER BAY, ON
P7B 6J3 CANADA

10,000 PCS
Approx. 34 lbs.



TIGHT STAR RECESS
NO STRIPPING



TAKES A T- 10 U-BIT

CUTTING NIBS



TRIM AND FINISHING

L- SHAPED CUTTING
TEETH



INTERIOR / EXTERIOR USE

TAPPER POINT
NO PREDRILLING



PATENT PENDING
MADE IN TAIWAN

190312 LOT 120319

F08101250B

FINE SCREW



8 X 1"1/4



U2 FASTENERS™
870 TUNGSTEN ST
THUNDER BAY, ON
P7B 6J3 CANADA

10,000 PCS
Approx. 34 lbs.



TIGHT STAR RECESS
NO STRIPPING



TAKES A T- 10 U-BIT

CUTTING NIBS



TRIM AND FINISHING

L- SHAPED CUTTING
TEETH



INTERIOR / EXTERIOR USE

TAPPER POINT
NO PREDRILLING



PATENT PENDING
MADE IN TAIWAN

190312 LOT 120319

F08101250B

FINE SCREW





8 X 1"1/2



U2 FASTENERS™
870 TUNGSTEN ST
THUNDER BAY, ON
P7B 6J3 CANADA

6,500 PCS
Approx. 26 lbs.



TIGHT STAR RECESS
NO STRIPPING



TAKES A T- 10 U-BIT

CUTTING NIBS



TRIM AND FINISHING

L- SHAPED CUTTING
TEETH



INTERIOR / EXTERIOR USE

TAPPER POINT
NO PREDRILLING



PATENT PENDING
MADE IN TAIWAN

190312 LOT 120319

F08101500B

FINE SCREW



8 X 1"1/2



U2 FASTENERS™
870 TUNGSTEN ST
THUNDER BAY, ON
P7B 6J3 CANADA

6,500 PCS
Approx. 26 lbs.



TIGHT STAR RECESS
NO STRIPPING



TAKES A T- 10 U-BIT

CUTTING NIBS



TRIM AND FINISHING

L- SHAPED CUTTING
TEETH



INTERIOR / EXTERIOR USE

TAPPER POINT
NO PREDRILLING



PATENT PENDING
MADE IN TAIWAN

190312 LOT 120319

F08101500B

FINE SCREW





8 X 2"



U2 FASTENERS™
870 TUNGSTEN ST
THUNDER BAY, ON
P7B 6J3 CANADA

4,500 PCS
Approx. 25 lbs.



TIGHT STAR RECESS
NO STRIPPING



TAKES A T- 10 U-BIT

CUTTING NIBS



TRIM AND FINISHING

L- SHAPED CUTTING
TEETH



INTERIOR / EXTERIOR USE

TAPPER POINT
NO PREDRILLING



PATENT PENDING
MADE IN TAIWAN

190312 LOT 120319

F08102000B

FINE SCREW



8 X 2"



U2 FASTENERS™
870 TUNGSTEN ST
THUNDER BAY, ON
P7B 6J3 CANADA

4,500 PCS
Approx. 25 lbs.



TIGHT STAR RECESS
NO STRIPPING



TAKES A T- 10 U-BIT

CUTTING NIBS



TRIM AND FINISHING

L- SHAPED CUTTING
TEETH



INTERIOR / EXTERIOR USE

TAPPER POINT
NO PREDRILLING



PATENT PENDING
MADE IN TAIWAN

190312 LOT 120319

F08102000B

FINE SCREW





8 X 2"1/2



U2 FASTENERS™
870 TUNGSTEN ST
THUNDER BAY, ON
P7B 6J3 CANADA

3,500 PCS
Approx. 24 lbs.



*TIGHT STAR RECESS
NO STRIPPING*



TAKES A T- 10 U-BIT

CUTTING NIBS



TRIM AND FINISHING

*L- SHAPED CUTTING
TEETH*



INTERIOR / EXTERIOR USE

*TAPPER POINT
NO PREDRILLING*



**PATENT PENDING
MADE IN TAIWAN**

190312 LOT 120319

F08102500B

FINE SCREW

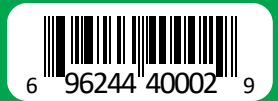

8 X 2"1/2



U2 FASTENERS™
870 TUNGSTEN ST
THUNDER BAY, ON
P7B 6J3 CANADA

3,500 PCS
Approx. 24 lbs.



*TIGHT STAR RECESS
NO STRIPPING*



TAKES A T- 10 U-BIT

CUTTING NIBS



TRIM AND FINISHING

*L- SHAPED CUTTING
TEETH*



INTERIOR / EXTERIOR USE

*TAPPER POINT
NO PREDRILLING*



**PATENT PENDING
MADE IN TAIWAN**

190312 LOT 120319

F08102500B

FINE SCREW

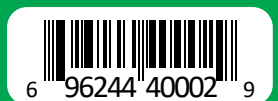



8 X 2"3/4



U2 FASTENERS™
870 TUNGSTEN ST
THUNDER BAY, ON
P7B 6J3 CANADA

3,000 PCS
Approx. 23 lbs.



TIGHT STAR RECESS
NO STRIPPING



TAKES A T- 10 U-BIT



CUTTING NIBS

TRIM AND FINISHING



L- SHAPED CUTTING
TEETH

INTERIOR / EXTERIOR USE



TAPPER POINT
NO PREDRILLING

PATENT PENDING
MADE IN TAIWAN

190312 LOT 120319

F08102750B

FINE SCREW

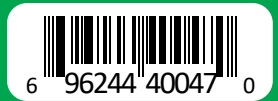

8 X 2"3/4



U2 FASTENERS™
870 TUNGSTEN ST
THUNDER BAY, ON
P7B 6J3 CANADA

3,000 PCS
Approx. 23 lbs.



TIGHT STAR RECESS
NO STRIPPING



TAKES A T- 10 U-BIT



CUTTING NIBS

TRIM AND FINISHING



L- SHAPED CUTTING
TEETH

INTERIOR / EXTERIOR USE



TAPPER POINT
NO PREDRILLING

PATENT PENDING
MADE IN TAIWAN

190312 LOT 120319

F08102750B

FINE SCREW

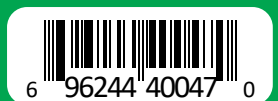



8 X 3"1/8



U2 FASTENERS™
870 TUNGSTEN ST
THUNDER BAY, ON
P7B 6J3 CANADA

2,000 PCS
Approx. 17 lbs.



TIGHT STAR RECESS
NO STRIPPING



TAKES A T- 10 U-BIT



CUTTING NIBS

TRIM AND FINISHING



L- SHAPED CUTTING
TEETH

INTERIOR / EXTERIOR USE



TAPPER POINT
NO PREDRILLING

PATENT PENDING
MADE IN TAIWAN

190312 LOT 120319

F08103125B

FINE SCREW

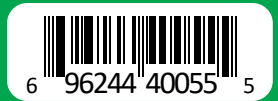

8 X 3"1/8



U2 FASTENERS™
870 TUNGSTEN ST
THUNDER BAY, ON
P7B 6J3 CANADA

2,000 PCS
Approx. 17 lbs.



TIGHT STAR RECESS
NO STRIPPING



TAKES A T- 10 U-BIT



CUTTING NIBS

TRIM AND FINISHING



L- SHAPED CUTTING
TEETH

INTERIOR / EXTERIOR USE



TAPPER POINT
NO PREDRILLING

PATENT PENDING
MADE IN TAIWAN

190312 LOT 120319

F08103125B

FINE SCREW





9 X 3"1/8



U2 FASTENERS™
870 TUNGSTEN ST
THUNDER BAY, ON
P7B 6J3 CANADA

2,000 PCS
Approx. 22 lbs.



TIGHT STAR RECESS
NO STRIPPING



TAKES A T-15 U-BIT



CUTTING NIBS

TRIM AND FINISHING

L- SHAPED CUTTING
TEETH



INTERIOR / EXTERIOR USE

TAPPER POINT
NO PREDRILLING



PATENT PENDING
MADE IN TAIWAN

190312 LOT 120319

F09103125B

FINE SCREW



9 X 3"1/8



U2 FASTENERS™
870 TUNGSTEN ST
THUNDER BAY, ON
P7B 6J3 CANADA

2,000 PCS
Approx. 22 lbs.



TIGHT STAR RECESS
NO STRIPPING



TAKES A T-15 U-BIT



CUTTING NIBS

TRIM AND FINISHING

L- SHAPED CUTTING
TEETH



INTERIOR / EXTERIOR USE

TAPPER POINT
NO PREDRILLING



PATENT PENDING
MADE IN TAIWAN

190312 LOT 120319

F09103125B

FINE SCREW





9 X 4"



U2 FASTENERS™
870 TUNGSTEN ST
THUNDER BAY, ON
P7B 6J3 CANADA

1,000 PCS
Approx. 14 lbs.



TIGHT STAR RECESS
NO STRIPPING



TAKES A T-15 U-BIT



CUTTING NIBS

TRIM AND FINISHING



L- SHAPED CUTTING
TEETH

INTERIOR / EXTERIOR USE



TAPPER POINT
NO PREDRILLING

PATENT PENDING
MADE IN TAIWAN

190312 LOT 120319

F09104000B

FINE SCREW



9 X 4"



U2 FASTENERS™
870 TUNGSTEN ST
THUNDER BAY, ON
P7B 6J3 CANADA

1,000 PCS
Approx. 14 lbs.



TIGHT STAR RECESS
NO STRIPPING



TAKES A T-15 U-BIT



CUTTING NIBS

TRIM AND FINISHING



L- SHAPED CUTTING
TEETH

INTERIOR / EXTERIOR USE



TAPPER POINT
NO PREDRILLING

PATENT PENDING
MADE IN TAIWAN

190312 LOT 120319

F09104000B

FINE SCREW





9 X 5"



U2 FASTENERS™
870 TUNGSTEN ST
THUNDER BAY, ON
P7B 6J3 CANADA

800 PCS
Approx. 14 lbs.



TIGHT STAR RECESS
NO STRIPPING



TAKES A T-15 U-BIT

CUTTING NIBS



TRIM AND FINISHING

L- SHAPED CUTTING
TEETH



INTERIOR / EXTERIOR USE

TAPPER POINT
NO PREDRILLING



PATENT PENDING
MADE IN TAIWAN

190312 LOT 120319

F09105000B

FINE SCREW

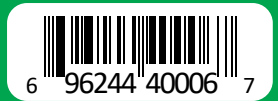

9 X 5"



U2 FASTENERS™
870 TUNGSTEN ST
THUNDER BAY, ON
P7B 6J3 CANADA

800 PCS
Approx. 14 lbs.



TIGHT STAR RECESS
NO STRIPPING



TAKES A T-15 U-BIT

CUTTING NIBS



TRIM AND FINISHING

L- SHAPED CUTTING
TEETH



INTERIOR / EXTERIOR USE

TAPPER POINT
NO PREDRILLING



PATENT PENDING
MADE IN TAIWAN

190312 LOT 120319

F09105000B

FINE SCREW





8 X 1"1/4



U2 FASTENERS™
870 TUNGSTEN ST
THUNDER BAY, ON
P7B 6J3 CANADA

10,000 PCS
Approx. 42 lbs.



TIGHT STAR RECESS
NO STRIPPING



TAKES A T-15 U-BIT

BURROW POCKETS



COUNTERSINK HEAD

L- SHAPED CUTTING
TEETH



STAINLESS STEEL

TAPPER POINT
NO PREDRILLING



PATENT PENDING
MADE IN TAIWAN

190312 LOT 120319

H08101250B

UNIVERSAL SCREW



8 X 1"1/4



U2 FASTENERS™
870 TUNGSTEN ST
THUNDER BAY, ON
P7B 6J3 CANADA

10,000 PCS
Approx. 42 lbs.



TIGHT STAR RECESS
NO STRIPPING



TAKES A T-15 U-BIT

BURROW POCKETS



COUNTERSINK HEAD

L- SHAPED CUTTING
TEETH



STAINLESS STEEL

TAPPER POINT
NO PREDRILLING



PATENT PENDING
MADE IN TAIWAN

190312 LOT 120319

H08101250B

UNIVERSAL SCREW





8 X 1"1/2



U2 FASTENERS™
870 TUNGSTEN ST
THUNDER BAY, ON
P7B 6J3 CANADA

6,500 PCS
Approx. 31 lbs.



TIGHT STAR RECESS
NO STRIPPING



TAKES A T-15 U-BIT

BURROW POCKETS



COUNTERSINK HEAD

L- SHAPED CUTTING
TEETH



STAINLESS STEEL

TAPPER POINT
NO PREDRILLING



PATENT PENDING
MADE IN TAIWAN

190312 LOT 120319

H08101500B

UNIVERSAL SCREW



8 X 1"1/2



U2 FASTENERS™
870 TUNGSTEN ST
THUNDER BAY, ON
P7B 6J3 CANADA

6,500 PCS
Approx. 31 lbs.



TIGHT STAR RECESS
NO STRIPPING



TAKES A T-15 U-BIT

BURROW POCKETS



COUNTERSINK HEAD

L- SHAPED CUTTING
TEETH

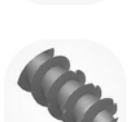

STAINLESS STEEL

TAPPER POINT
NO PREDRILLING



PATENT PENDING
MADE IN TAIWAN

190312 LOT 120319

H08101500B

UNIVERSAL SCREW





8 X 1"3/4



U2 FASTENERS™
870 TUNGSTEN ST
THUNDER BAY, ON
P7B 6J3 CANADA

5,000 PCS
Approx. 28 lbs.



TIGHT STAR RECESS
NO STRIPPING



TAKES A T-15 U-BIT

BURROW POCKETS



COUNTERSINK HEAD

L- SHAPED CUTTING
TEETH



STAINLESS STEEL

TAPPER POINT
NO PREDRILLING



PATENT PENDING
MADE IN TAIWAN

190312 LOT 120319

H08101750B

UNIVERSAL SCREW



8 X 1"3/4



U2 FASTENERS™
870 TUNGSTEN ST
THUNDER BAY, ON
P7B 6J3 CANADA

5,000 PCS
Approx. 28 lbs.



TIGHT STAR RECESS
NO STRIPPING



TAKES A T-15 U-BIT

BURROW POCKETS



COUNTERSINK HEAD

L- SHAPED CUTTING
TEETH



STAINLESS STEEL

TAPPER POINT
NO PREDRILLING



PATENT PENDING
MADE IN TAIWAN

190312 LOT 120319

H08101750B

UNIVERSAL SCREW





9 X 1"1/2



U2 FASTENERS™
870 TUNGSTEN ST
THUNDER BAY, ON
P7B 6J3 CANADA

5,000 PCS
Approx. 31 lbs.



TIGHT STAR RECESS
NO STRIPPING



TAKES A T-25 U-BIT

BURROW POCKETS



COUNTERSINK HEAD

L- SHAPED CUTTING
TEETH



STAINLESS STEEL

TAPPER POINT
NO PREDRILLING



PATENT PENDING
MADE IN TAIWAN

190312 LOT 120319

H09101500B

UNIVERSAL SCREW



9 X 1"1/2



U2 FASTENERS™
870 TUNGSTEN ST
THUNDER BAY, ON
P7B 6J3 CANADA

5,000 PCS
Approx. 31 lbs.



TIGHT STAR RECESS
NO STRIPPING



TAKES A T-25 U-BIT

BURROW POCKETS



COUNTERSINK HEAD

L- SHAPED CUTTING
TEETH



STAINLESS STEEL

TAPPER POINT
NO PREDRILLING



PATENT PENDING
MADE IN TAIWAN

190312 LOT 120319

H09101500B

UNIVERSAL SCREW





9 X 2"



U2 FASTENERS™
870 TUNGSTEN ST
THUNDER BAY, ON
P7B 6J3 CANADA

3,700 PCS
Approx. 30 lbs.



TIGHT STAR RECESS
NO STRIPPING



TAKES A T-25 U-BIT

BURROW POCKETS



COUNTERSINK HEAD

REAMER THREAD



STAINLESS STEEL

TAPPER POINT
NO PREDRILLING



PATENT PENDING
MADE IN TAIWAN

190312 LOT 120319

H09102000B

UNIVERSAL SCREW



9 X 2"



U2 FASTENERS™
870 TUNGSTEN ST
THUNDER BAY, ON
P7B 6J3 CANADA

3,700 PCS
Approx. 30 lbs.



TIGHT STAR RECESS
NO STRIPPING



TAKES A T-25 U-BIT

BURROW POCKETS



COUNTERSINK HEAD

REAMER THREAD



STAINLESS STEEL

TAPPER POINT
NO PREDRILLING



PATENT PENDING
MADE IN TAIWAN

190312 LOT 120319

H09102000B

UNIVERSAL SCREW





10 X 2"1/2



U2 FASTENERS™
870 TUNGSTEN ST
THUNDER BAY, ON
P7B 6J3 CANADA

2,200 PCS
Approx. 27 lbs.



TIGHT STAR RECESS
NO STRIPPING



TAKES A T-25 U-BIT

BURROW POCKETS



COUNTERSINK HEAD

REAMER THREAD



STAINLESS STEEL

TAPPER POINT
NO PREDRILLING



PATENT PENDING
MADE IN TAIWAN

190312 LOT 120319

H10102500B

UNIVERSAL SCREW



10 X 2"1/2



U2 FASTENERS™
870 TUNGSTEN ST
THUNDER BAY, ON
P7B 6J3 CANADA

2,200 PCS
Approx. 27 lbs.



TIGHT STAR RECESS
NO STRIPPING



TAKES A T-25 U-BIT

BURROW POCKETS



COUNTERSINK HEAD

REAMER THREAD



STAINLESS STEEL

TAPPER POINT
NO PREDRILLING



PATENT PENDING
MADE IN TAIWAN

190312 LOT 120319

H10102500B

UNIVERSAL SCREW





10 X 2"3/4



U2 FASTENERS™
870 TUNGSTEN ST
THUNDER BAY, ON
P7B 6J3 CANADA

2,000 PCS
Approx. 28 lbs.



TIGHT STAR RECESS
NO STRIPPING



TAKES A T-25 U-BIT

BURROW POCKETS



COUNTERSINK HEAD

REAMER THREAD



STAINLESS STEEL

TAPPER POINT
NO PREDRILLING



PATENT PENDING
MADE IN TAIWAN

190312 LOT 120319

H10102750B

UNIVERSAL SCREW



10 X 2"3/4



U2 FASTENERS™
870 TUNGSTEN ST
THUNDER BAY, ON
P7B 6J3 CANADA

2,000 PCS
Approx. 28 lbs.



TIGHT STAR RECESS
NO STRIPPING



TAKES A T-25 U-BIT

BURROW POCKETS



COUNTERSINK HEAD

REAMER THREAD



STAINLESS STEEL

TAPPER POINT
NO PREDRILLING



PATENT PENDING
MADE IN TAIWAN

190312 LOT 120319

H10102750B

UNIVERSAL SCREW





10 X 3"



U2 FASTENERS™
870 TUNGSTEN ST
THUNDER BAY, ON
P7B 6J3 CANADA

1,500 PCS
Approx. 22 lbs.



TIGHT STAR RECESS
NO STRIPPING



TAKES A T-25 U-BIT

BURROW POCKETS



COUNTERSINK HEAD

REAMER THREAD



STAINLESS STEEL

TAPPER POINT
NO PREDRILLING



PATENT PENDING
MADE IN TAIWAN

190312 LOT 120319

H10103000B

UNIVERSAL SCREW



10 X 3"



U2 FASTENERS™
870 TUNGSTEN ST
THUNDER BAY, ON
P7B 6J3 CANADA

1,500 PCS
Approx. 22 lbs.



TIGHT STAR RECESS
NO STRIPPING



TAKES A T-25 U-BIT

BURROW POCKETS



COUNTERSINK HEAD

REAMER THREAD



STAINLESS STEEL

TAPPER POINT
NO PREDRILLING



PATENT PENDING
MADE IN TAIWAN

190312 LOT 120319

H10103000B

UNIVERSAL SCREW





10 X 4"



U2 FASTENERS™
870 TUNGSTEN ST
THUNDER BAY, ON
P7B 6J3 CANADA

1,000 PCS
Approx. 20 lbs.



TIGHT STAR RECESS
NO STRIPPING



TAKES A T-25 U-BIT

BURROW POCKETS



COUNTERSINK HEAD

REAMER THREAD



STAINLESS STEEL

TAPPER POINT
NO PREDRILLING



PATENT PENDING
MADE IN TAIWAN

190312 LOT 120319

H10104000B

UNIVERSAL SCREW



10 X 4"



U2 FASTENERS™
870 TUNGSTEN ST
THUNDER BAY, ON
P7B 6J3 CANADA

1,000 PCS
Approx. 20 lbs.



TIGHT STAR RECESS
NO STRIPPING



TAKES A T-25 U-BIT

BURROW POCKETS



COUNTERSINK HEAD

REAMER THREAD



STAINLESS STEEL

TAPPER POINT
NO PREDRILLING



PATENT PENDING
MADE IN TAIWAN

190312 LOT 120319

H10104000B

UNIVERSAL SCREW



U² FASTENERS™

10 X 1"1/2



U2 FASTENERS™
870 TUNGSTEN ST
THUNDER BAY, ON
P7B 6J3 CANADA



2,300 PCS
Approx. 26 lbs.



TIGHT STAR RECESS
NO STRIPPING



TAKES A T-25 U-BIT



WASHER HEAD WITH
TALON GRIP

FRAMING



L- SHAPED CUTTING
TEETH

STAINLESS STEEL



TAPPER POINT
NO PREDRILLING

PATENT PENDING
MADE IN TAIWAN

190312 LOT 120319

I10101500B

CONSTRUCTION SCREW



U² FASTENERS™

10 X 1"1/2



U2 FASTENERS™
870 TUNGSTEN ST
THUNDER BAY, ON
P7B 6J3 CANADA



2,300 PCS
Approx. 26 lbs.



TIGHT STAR RECESS
NO STRIPPING



TAKES A T-25 U-BIT



WASHER HEAD WITH
TALON GRIP

FRAMING



L- SHAPED CUTTING
TEETH

STAINLESS STEEL



TAPPER POINT
NO PREDRILLING

PATENT PENDING
MADE IN TAIWAN

190312 LOT 120319

I10101500B

CONSTRUCTION SCREW





1/4 X 2"



U2 FASTENERS™
870 TUNGSTEN ST
THUNDER BAY, ON
P7B 6J3 CANADA

800 PCS
Approx. 12 lbs.



TIGHT STAR RECESS
NO STRIPPING



TAKES A T-25 U-BIT

WASHER HEAD WITH
TALON GRIP



FRAMING

L- SHAPED CUTTING
TEETH



STAINLESS STEEL

TAPPER POINT
NO PREDRILLING



PATENT PENDING
MADE IN TAIWAN

190312 LOT 120319

I14102000B

CONSTRUCTION SCREW



1/4 X 2"



U2 FASTENERS™
870 TUNGSTEN ST
THUNDER BAY, ON
P7B 6J3 CANADA

800 PCS
Approx. 12 lbs.



TIGHT STAR RECESS
NO STRIPPING



TAKES A T-25 U-BIT

WASHER HEAD WITH
TALON GRIP



FRAMING

L- SHAPED CUTTING
TEETH



STAINLESS STEEL

TAPPER POINT
NO PREDRILLING



PATENT PENDING
MADE IN TAIWAN

190312 LOT 120319

I14102000B

CONSTRUCTION SCREW





5/16 X 2"1/2



U2 FASTENERS™
870 TUNGSTEN ST
THUNDER BAY, ON
P7B 6J3 CANADA

600 PCS
Approx. 16 lbs.



TIGHT STAR RECESS
NO STRIPPING



TAKES A T- 30 U-BIT



WASHER HEAD WITH
TALON GRIP

FRAMING



REAMER THREAD

STAINLESS STEEL



TAPPER POINT
NO PREDRILLING

PATENT PENDING
MADE IN TAIWAN

190312 LOT 120319

I20102500B

CONSTRUCTION SCREW



5/16 X 2"1/2



U2 FASTENERS™
870 TUNGSTEN ST
THUNDER BAY, ON
P7B 6J3 CANADA

600 PCS
Approx. 16 lbs.



TIGHT STAR RECESS
NO STRIPPING



TAKES A T- 30 U-BIT



WASHER HEAD WITH
TALON GRIP

FRAMING



REAMER THREAD

STAINLESS STEEL



TAPPER POINT
NO PREDRILLING

PATENT PENDING
MADE IN TAIWAN

190312 LOT 120319

I20102500B

CONSTRUCTION SCREW





5/16 X 3"



U2 FASTENERS™
870 TUNGSTEN ST
THUNDER BAY, ON
P7B 6J3 CANADA

500 PCS
Approx. 16 lbs.



TIGHT STAR RECESS
NO STRIPPING



TAKES A T- 30 U-BIT



WASHER HEAD WITH
TALON GRIP

FRAMING



REAMER THREAD

STAINLESS STEEL



TAPPER POINT
NO PREDRILLING

PATENT PENDING
MADE IN TAIWAN

190312 LOT 120319

I20103000B

CONSTRUCTION SCREW



5/16 X 3"



U2 FASTENERS™
870 TUNGSTEN ST
THUNDER BAY, ON
P7B 6J3 CANADA

500 PCS
Approx. 16 lbs.



TIGHT STAR RECESS
NO STRIPPING



TAKES A T- 30 U-BIT



WASHER HEAD WITH
TALON GRIP

FRAMING



REAMER THREAD

STAINLESS STEEL



TAPPER POINT
NO PREDRILLING

PATENT PENDING
MADE IN TAIWAN

190312 LOT 120319

I20103000B

CONSTRUCTION SCREW





5/16 X 4"



U2 FASTENERS™
870 TUNGSTEN ST
THUNDER BAY, ON
P7B 6J3 CANADA

400 PCS
Approx. 17 lbs.



TIGHT STAR RECESS
NO STRIPPING



TAKES A T- 30 U-BIT



WASHER HEAD WITH
TALON GRIP

FRAMING



REAMER THREAD

STAINLESS STEEL

TAPPER POINT
NO PREDRILLING



PATENT PENDING
MADE IN TAIWAN

190312 LOT 120319

I20104000B

CONSTRUCTION SCREW



5/16 X 4"



U2 FASTENERS™
870 TUNGSTEN ST
THUNDER BAY, ON
P7B 6J3 CANADA

400 PCS
Approx. 17 lbs.



TIGHT STAR RECESS
NO STRIPPING



TAKES A T- 30 U-BIT



WASHER HEAD WITH
TALON GRIP

FRAMING



REAMER THREAD

STAINLESS STEEL

TAPPER POINT
NO PREDRILLING



PATENT PENDING
MADE IN TAIWAN

190312 LOT 120319

I20104000B

CONSTRUCTION SCREW





5/16 X 5"



U2 FASTENERS™
870 TUNGSTEN ST
THUNDER BAY, ON
P7B 6J3 CANADA

300 PCS
Approx. 15 lbs.



TIGHT STAR RECESS
NO STRIPPING



TAKES A T- 30 U-BIT



WASHER HEAD WITH
TALON GRIP

FRAMING



REAMER THREAD

STAINLESS STEEL

TAPPER POINT
NO PREDRILLING



PATENT PENDING
MADE IN TAIWAN

190312 LOT 120319

I20105000B

CONSTRUCTION SCREW



5/16 X 5"



U2 FASTENERS™
870 TUNGSTEN ST
THUNDER BAY, ON
P7B 6J3 CANADA

300 PCS
Approx. 15 lbs.



TIGHT STAR RECESS
NO STRIPPING



TAKES A T- 30 U-BIT



WASHER HEAD WITH
TALON GRIP

FRAMING



REAMER THREAD

STAINLESS STEEL

TAPPER POINT
NO PREDRILLING



PATENT PENDING
MADE IN TAIWAN

190312 LOT 120319

I20105000B

CONSTRUCTION SCREW





5/16 X 6"



U2 FASTENERS™
870 TUNGSTEN ST
THUNDER BAY, ON
P7B 6J3 CANADA

300 PCS
Approx. 18 lbs.



TIGHT STAR RECESS
NO STRIPPING



TAKES A T- 30 U-BIT



WASHER HEAD WITH
TALON GRIP

FRAMING



REAMER THREAD

STAINLESS STEEL

TAPPER POINT
NO PREDRILLING



PATENT PENDING
MADE IN TAIWAN

190312 LOT 120319

I20106000B

CONSTRUCTION SCREW



5/16 X 6"



U2 FASTENERS™
870 TUNGSTEN ST
THUNDER BAY, ON
P7B 6J3 CANADA

300 PCS
Approx. 18 lbs.



TIGHT STAR RECESS
NO STRIPPING



TAKES A T- 30 U-BIT



WASHER HEAD WITH
TALON GRIP

FRAMING



REAMER THREAD

STAINLESS STEEL

TAPPER POINT
NO PREDRILLING



PATENT PENDING
MADE IN TAIWAN

190312 LOT 120319

I20106000B

CONSTRUCTION SCREW





8 X 1"1/4



U2 FASTENERS™
870 TUNGSTEN ST
THUNDER BAY, ON
P7B 6J3 CANADA

4,000 PCS
Approx. 20 lbs.

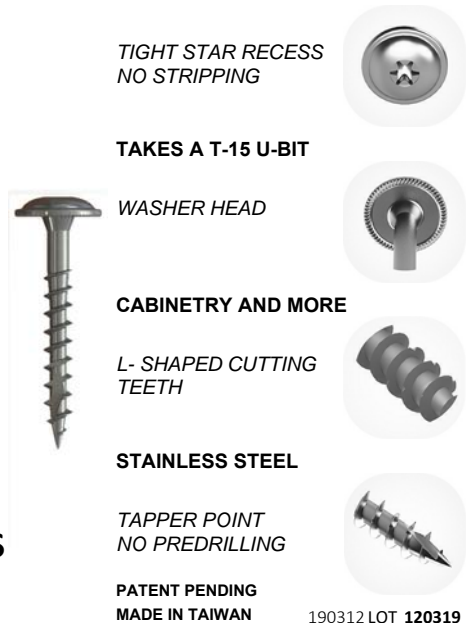

190312 LOT 120319

J08101250B

CAP SCREW



8 X 1"1/4



U2 FASTENERS™
870 TUNGSTEN ST
THUNDER BAY, ON
P7B 6J3 CANADA

4,000 PCS
Approx. 20 lbs.

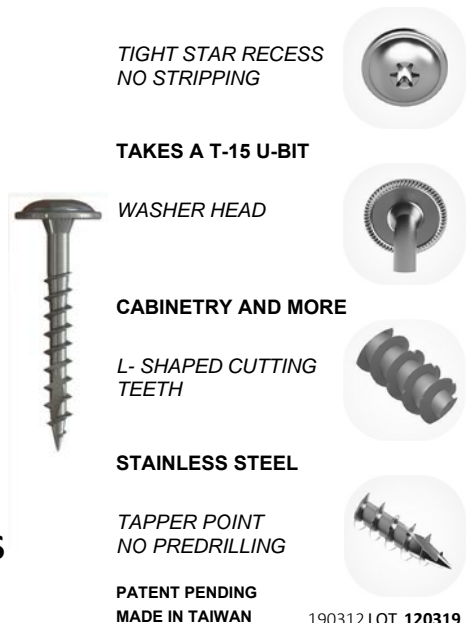

190312 LOT 120319

J08101250B

CAP SCREW





8 X 1"1/2



U2 FASTENERS™
870 TUNGSTEN ST
THUNDER BAY, ON
P7B 6J3 CANADA

3,000 PCS
Approx. 21 lbs.

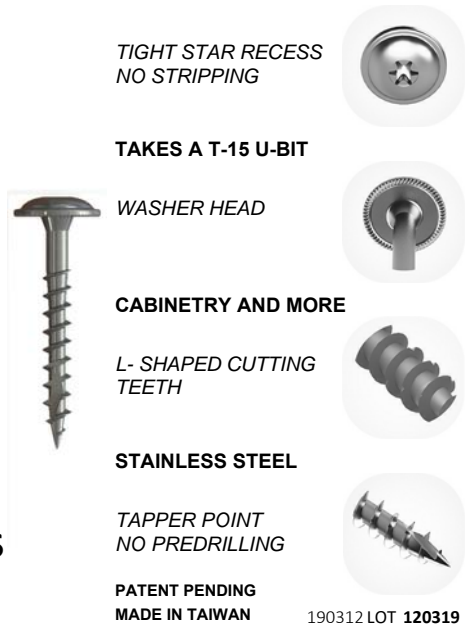

190312 LOT 120319

J08101500B

CAP SCREW



8 X 1"1/2



U2 FASTENERS™
870 TUNGSTEN ST
THUNDER BAY, ON
P7B 6J3 CANADA

3,000 PCS
Approx. 21 lbs.

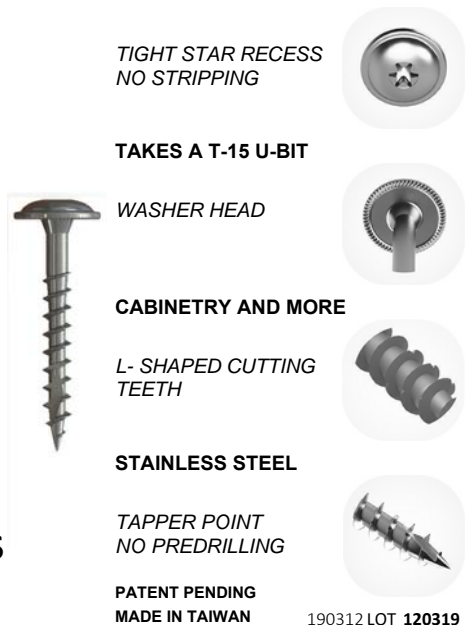

190312 LOT 120319

J08101500B

CAP SCREW





8 X 1"1/2



U2 FASTENERS™
870 TUNGSTEN ST
THUNDER BAY, ON
P7B 6J3 CANADA

6,500 PCS
Approx. 28 lbs.



TIGHT STAR RECESS
NO STRIPPING



TAKES A T- 10 U-BIT

CUTTING NIBS



TRIM AND FINISHING

L- SHAPED CUTTING
TEETH



STAINLESS STEEL

TAPPER POINT
NO PREDRILLING



PATENT PENDING
MADE IN TAIWAN

190312 LOT 120319

K08101500B

FINE SCREW



8 X 1"1/2



U2 FASTENERS™
870 TUNGSTEN ST
THUNDER BAY, ON
P7B 6J3 CANADA

6,500 PCS
Approx. 28 lbs.



TIGHT STAR RECESS
NO STRIPPING



TAKES A T- 10 U-BIT

CUTTING NIBS



TRIM AND FINISHING

L- SHAPED CUTTING
TEETH



STAINLESS STEEL

TAPPER POINT
NO PREDRILLING



PATENT PENDING
MADE IN TAIWAN

190312 LOT 120319

K08101500B

FINE SCREW





8 X 2"



U2 FASTENERS™
870 TUNGSTEN ST
THUNDER BAY, ON
P7B 6J3 CANADA

4,500 PCS
Approx. 26 lbs.



TIGHT STAR RECESS
NO STRIPPING



TAKES A T- 10 U-BIT



CUTTING NIBS

TRIM AND FINISHING

L- SHAPED CUTTING
TEETH



STAINLESS STEEL

TAPPER POINT
NO PREDRILLING



PATENT PENDING
MADE IN TAIWAN

190312 LOT 120319

K08102000B

FINE SCREW



8 X 2"



U2 FASTENERS™
870 TUNGSTEN ST
THUNDER BAY, ON
P7B 6J3 CANADA

4,500 PCS
Approx. 26 lbs.



TIGHT STAR RECESS
NO STRIPPING



TAKES A T- 10 U-BIT



CUTTING NIBS

TRIM AND FINISHING

L- SHAPED CUTTING
TEETH



STAINLESS STEEL

TAPPER POINT
NO PREDRILLING



PATENT PENDING
MADE IN TAIWAN

190312 LOT 120319

K08102000B

FINE SCREW





8 X 2"1/2



U2 FASTENERS™
870 TUNGSTEN ST
THUNDER BAY, ON
P7B 6J3 CANADA

3,500 PCS
Approx. 25 lbs.



TIGHT STAR RECESS
NO STRIPPING



TAKES A T- 10 U-BIT

CUTTING NIBS



TRIM AND FINISHING

L- SHAPED CUTTING
TEETH



STAINLESS STEEL

TAPPER POINT
NO PREDRILLING



PATENT PENDING
MADE IN TAIWAN

190312 LOT 120319

K08102500B

FINE SCREW



8 X 2"1/2



U2 FASTENERS™
870 TUNGSTEN ST
THUNDER BAY, ON
P7B 6J3 CANADA

3,500 PCS
Approx. 25 lbs.



TIGHT STAR RECESS
NO STRIPPING



TAKES A T- 10 U-BIT

CUTTING NIBS



TRIM AND FINISHING

L- SHAPED CUTTING
TEETH



STAINLESS STEEL

TAPPER POINT
NO PREDRILLING



PATENT PENDING
MADE IN TAIWAN

190312 LOT 120319

K08102500B

FINE SCREW





8 X 3"



U2 FASTENERS™
870 TUNGSTEN ST
THUNDER BAY, ON
P7B 6J3 CANADA

2,000 PCS
Approx. 18 lbs.



TIGHT STAR RECESS
NO STRIPPING



TAKES A T- 10 U-BIT

CUTTING NIBS



TRIM AND FINISHING

L- SHAPED CUTTING
TEETH



STAINLESS STEEL

TAPPER POINT
NO PREDRILLING



PATENT PENDING
MADE IN TAIWAN

190312 LOT 120319

K08103000B

FINE SCREW



8 X 3"



U2 FASTENERS™
870 TUNGSTEN ST
THUNDER BAY, ON
P7B 6J3 CANADA

2,000 PCS
Approx. 18 lbs.



TIGHT STAR RECESS
NO STRIPPING



TAKES A T- 10 U-BIT

CUTTING NIBS



TRIM AND FINISHING

L- SHAPED CUTTING
TEETH



STAINLESS STEEL

TAPPER POINT
NO PREDRILLING



PATENT PENDING
MADE IN TAIWAN

190312 LOT 120319

K08103000B

FINE SCREW





9 X 3"



U2 FASTENERS™
870 TUNGSTEN ST
THUNDER BAY, ON
P7B 6J3 CANADA

2,000 PCS
Approx. 23 lbs.



TIGHT STAR RECESS
NO STRIPPING



TAKES A T-15 U-BIT

CUTTING NIBS



TRIM AND FINISHING

L- SHAPED CUTTING
TEETH



STAINLESS STEEL

TAPPER POINT
NO PREDRILLING



PATENT PENDING
MADE IN TAIWAN

190312 LOT 120319

K09103000B

FINE SCREW



9 X 3"



U2 FASTENERS™
870 TUNGSTEN ST
THUNDER BAY, ON
P7B 6J3 CANADA

2,000 PCS
Approx. 23 lbs.



TIGHT STAR RECESS
NO STRIPPING



TAKES A T-15 U-BIT

CUTTING NIBS



TRIM AND FINISHING

L- SHAPED CUTTING
TEETH



STAINLESS STEEL

TAPPER POINT
NO PREDRILLING



PATENT PENDING
MADE IN TAIWAN

190312 LOT 120319

K09103000B

FINE SCREW





8 X 2"



U2 FASTENERS™
870 TUNGSTEN ST
THUNDER BAY, ON
P7B 6J3 CANADA

4,500 PCS
Approx. 24 lbs.



TIGHT STAR RECESS
NO STRIPPING



TAKES A T- 10 U-BIT

CUTTING NIBS /
REVERSE THREAD



TRIM AND FINISHING

L- SHAPED CUTTING
TEETH



INTERIOR / EXTERIOR USE

TAPPER POINT
NO PREDRILLING



PATENT PENDING
MADE IN TAIWAN

190312 LOT 120319

Q0810200B

WHITE-RE-FINE SCREW



8 X 2"



U2 FASTENERS™
870 TUNGSTEN ST
THUNDER BAY, ON
P7B 6J3 CANADA

4,500 PCS
Approx. 24 lbs.



TIGHT STAR RECESS
NO STRIPPING



TAKES A T- 10 U-BIT

CUTTING NIBS /
REVERSE THREAD



TRIM AND FINISHING

L- SHAPED CUTTING
TEETH



INTERIOR / EXTERIOR USE

TAPPER POINT
NO PREDRILLING



PATENT PENDING
MADE IN TAIWAN

190312 LOT 120319

Q0810200B

WHITE-RE-FINE SCREW





8 X 2"1/2



U2 FASTENERS™
870 TUNGSTEN ST
THUNDER BAY, ON
P7B 6J3 CANADA

3,500 PCS
Approx. 25 lbs.



TIGHT STAR RECESS
NO STRIPPING



TAKES A T- 10 U-BIT

CUTTING NIBS /
REVERSE THREAD



TRIM AND FINISHING

L- SHAPED CUTTING
TEETH



INTERIOR / EXTERIOR USE

TAPPER POINT
NO PREDRILLING



PATENT PENDING
MADE IN TAIWAN

190312 LOT 120319

Q08102500B

WHITE-RE-FINE SCREW



8 X 2"1/2



U2 FASTENERS™
870 TUNGSTEN ST
THUNDER BAY, ON
P7B 6J3 CANADA

3,500 PCS
Approx. 25 lbs.



TIGHT STAR RECESS
NO STRIPPING



TAKES A T- 10 U-BIT

CUTTING NIBS /
REVERSE THREAD



TRIM AND FINISHING

L- SHAPED CUTTING
TEETH



INTERIOR / EXTERIOR USE

TAPPER POINT
NO PREDRILLING



PATENT PENDING
MADE IN TAIWAN

190312 LOT 120319

Q08102500B

WHITE-RE-FINE SCREW





8 X 2"3/4



U2 FASTENERS™
870 TUNGSTEN ST
THUNDER BAY, ON
P7B 6J3 CANADA

3,000 PCS
Approx. 23 lbs.



TIGHT STAR RECESS
NO STRIPPING



TAKES A T- 10 U-BIT

CUTTING NIBS /
REVERSE THREAD



TRIM AND FINISHING

L- SHAPED CUTTING
TEETH



INTERIOR / EXTERIOR USE

TAPPER POINT
NO PREDRILLING



PATENT PENDING
MADE IN TAIWAN

190312 LOT 120319

Q08102750B

WHITE-RE-FINE SCREW



8 X 2"3/4



U2 FASTENERS™
870 TUNGSTEN ST
THUNDER BAY, ON
P7B 6J3 CANADA

3,000 PCS
Approx. 23 lbs.



TIGHT STAR RECESS
NO STRIPPING



TAKES A T- 10 U-BIT

CUTTING NIBS /
REVERSE THREAD



TRIM AND FINISHING

L- SHAPED CUTTING
TEETH



INTERIOR / EXTERIOR USE

TAPPER POINT
NO PREDRILLING



PATENT PENDING
MADE IN TAIWAN

190312 LOT 120319

Q08102750B

WHITE-RE-FINE SCREW





8 X 3"1/8



U2 FASTENERS™
870 TUNGSTEN ST
THUNDER BAY, ON
P7B 6J3 CANADA

2,000 PCS
Approx. 18 lbs.



TIGHT STAR RECESS
NO STRIPPING



TAKES A T- 10 U-BIT

CUTTING NIBS /
REVERSE THREAD



TRIM AND FINISHING

L- SHAPED CUTTING
TEETH



INTERIOR / EXTERIOR USE

TAPPER POINT
NO PREDRILLING



PATENT PENDING
MADE IN TAIWAN

190312 LOT 120319

Q08103125B

WHITE-RE-FINE SCREW



8 X 3"1/8



U2 FASTENERS™
870 TUNGSTEN ST
THUNDER BAY, ON
P7B 6J3 CANADA

2,000 PCS
Approx. 18 lbs.



TIGHT STAR RECESS
NO STRIPPING



TAKES A T- 10 U-BIT

CUTTING NIBS /
REVERSE THREAD



TRIM AND FINISHING

L- SHAPED CUTTING
TEETH



INTERIOR / EXTERIOR USE

TAPPER POINT
NO PREDRILLING



PATENT PENDING
MADE IN TAIWAN

190312 LOT 120319

Q08103125B

WHITE-RE-FINE SCREW





8 X 2"



U2 FASTENERS™
870 TUNGSTEN ST
THUNDER BAY, ON
P7B 6J3 CANADA

4,500 PCS
Approx. 24 lbs.



TIGHT STAR RECESS
NO STRIPPING



TAKES A T- 10 U-BIT

CUTTING NIBS /
REVERSE THREAD



TRIM AND FINISHING

L- SHAPED CUTTING
TEETH



INTERIOR / EXTERIOR USE

TAPPER POINT
NO PREDRILLING



PATENT PENDING
MADE IN TAIWAN

190312 LOT 120319

R0810200B

RE-FINE SCREW



8 X 2"



U2 FASTENERS™
870 TUNGSTEN ST
THUNDER BAY, ON
P7B 6J3 CANADA

4,500 PCS
Approx. 24 lbs.



TIGHT STAR RECESS
NO STRIPPING



TAKES A T- 10 U-BIT

CUTTING NIBS /
REVERSE THREAD



TRIM AND FINISHING

L- SHAPED CUTTING
TEETH



INTERIOR / EXTERIOR USE

TAPPER POINT
NO PREDRILLING



PATENT PENDING
MADE IN TAIWAN

190312 LOT 120319

R0810200B

RE-FINE SCREW





8 X 2"1/2



U2 FASTENERS™
870 TUNGSTEN ST
THUNDER BAY, ON
P7B 6J3 CANADA

3,500 PCS
Approx. 25 lbs.



TIGHT STAR RECESS
NO STRIPPING



TAKES A T- 10 U-BIT

CUTTING NIBS /
REVERSE THREAD



TRIM AND FINISHING

L- SHAPED CUTTING
TEETH



INTERIOR / EXTERIOR USE

TAPPER POINT
NO PREDRILLING



PATENT PENDING
MADE IN TAIWAN

190312 LOT 120319

R08102500B

RE-FINE SCREW



8 X 2"1/2



U2 FASTENERS™
870 TUNGSTEN ST
THUNDER BAY, ON
P7B 6J3 CANADA

3,500 PCS
Approx. 25 lbs.



TIGHT STAR RECESS
NO STRIPPING



TAKES A T- 10 U-BIT

CUTTING NIBS /
REVERSE THREAD



TRIM AND FINISHING

L- SHAPED CUTTING
TEETH



INTERIOR / EXTERIOR USE

TAPPER POINT
NO PREDRILLING



PATENT PENDING
MADE IN TAIWAN

190312 LOT 120319

R08102500B

RE-FINE SCREW





8 X 3"1/8



U2 FASTENERS™
870 TUNGSTEN ST
THUNDER BAY, ON
P7B 6J3 CANADA

2,000 PCS
Approx. 18 lbs.



TIGHT STAR RECESS
NO STRIPPING



TAKES A T- 10 U-BIT

CUTTING NIBS /
REVERSE THREAD



TRIM AND FINISHING

L- SHAPED CUTTING
TEETH



INTERIOR / EXTERIOR USE

TAPPER POINT
NO PREDRILLING



PATENT PENDING
MADE IN TAIWAN

190312 LOT 120319

R08103125B

RE-FINE SCREW



8 X 3"1/8



U2 FASTENERS™
870 TUNGSTEN ST
THUNDER BAY, ON
P7B 6J3 CANADA

2,000 PCS
Approx. 18 lbs.



TIGHT STAR RECESS
NO STRIPPING



TAKES A T- 10 U-BIT

CUTTING NIBS /
REVERSE THREAD



TRIM AND FINISHING

L- SHAPED CUTTING
TEETH



INTERIOR / EXTERIOR USE

TAPPER POINT
NO PREDRILLING



PATENT PENDING
MADE IN TAIWAN

190312 LOT 120319

R08103125B

RE-FINE SCREW





9 X 3"1/8



U2 FASTENERS™
870 TUNGSTEN ST
THUNDER BAY, ON
P7B 6J3 CANADA

2,000 PCS
Approx. 22 lbs.



TIGHT STAR RECESS
NO STRIPPING



TAKES A T-15 U-BIT

CUTTING NIBS /
REVERSE THREAD



TRIM AND FINISHING

L- SHAPED CUTTING
TEETH



INTERIOR / EXTERIOR USE

TAPPER POINT
NO PREDRILLING



PATENT PENDING
MADE IN TAIWAN

190312 LOT 120319

R09103125B

RE-FINE SCREW



9 X 3"1/8



U2 FASTENERS™
870 TUNGSTEN ST
THUNDER BAY, ON
P7B 6J3 CANADA

2,000 PCS
Approx. 22 lbs.



TIGHT STAR RECESS
NO STRIPPING



TAKES A T-15 U-BIT

CUTTING NIBS /
REVERSE THREAD



TRIM AND FINISHING

L- SHAPED CUTTING
TEETH



INTERIOR / EXTERIOR USE

TAPPER POINT
NO PREDRILLING



PATENT PENDING
MADE IN TAIWAN

190312 LOT 120319

R09103125B

RE-FINE SCREW



U² FASTENERS™

10 X 1"1/2



U2 FASTENERS™
870 TUNGSTEN ST
THUNDER BAY, ON
P7B 6J3 CANADA



2,300 PCS
Approx. 21 lbs.



TIGHT STAR RECESS
NO STRIPPING



TAKES A T-25 U-BIT

WASHER HEAD WITH
TALON GRIP



FRAMING

L- SHAPED CUTTING
TEETH



INTERIOR / EXTERIOR USE

TAPPER POINT
NO PREDRILLING



PATENT PENDING
MADE IN TAIWAN

190312 LOT 120319

S10101500B

CONSTRUCTION SCREW



U² FASTENERS™

10 X 1"1/2



U2 FASTENERS™
870 TUNGSTEN ST
THUNDER BAY, ON
P7B 6J3 CANADA



2,300 PCS
Approx. 21 lbs.



TIGHT STAR RECESS
NO STRIPPING



TAKES A T-25 U-BIT

WASHER HEAD WITH
TALON GRIP



FRAMING

L- SHAPED CUTTING
TEETH



INTERIOR / EXTERIOR USE

TAPPER POINT
NO PREDRILLING



PATENT PENDING
MADE IN TAIWAN

190312 LOT 120319

S10101500B

CONSTRUCTION SCREW





10 X 2"



U2 FASTENERS™
870 TUNGSTEN ST
THUNDER BAY, ON
P7B 6J3 CANADA

1,600 PCS
Approx. 18 lbs.



TIGHT STAR RECESS
NO STRIPPING



TAKES A T-25 U-BIT



WASHER HEAD WITH
TALON GRIP

FRAMING



L-SHAPED CUTTING
TEETH

INTERIOR / EXTERIOR USE



TAPPER POINT
NO PREDRILLING

PATENT PENDING
MADE IN TAIWAN

190312 LOT 120319

S10102000B

CONSTRUCTION SCREW



10 X 2"



U2 FASTENERS™
870 TUNGSTEN ST
THUNDER BAY, ON
P7B 6J3 CANADA

1,600 PCS
Approx. 18 lbs.



TIGHT STAR RECESS
NO STRIPPING



TAKES A T-25 U-BIT



WASHER HEAD WITH
TALON GRIP

FRAMING



L-SHAPED CUTTING
TEETH

INTERIOR / EXTERIOR USE



TAPPER POINT
NO PREDRILLING

PATENT PENDING
MADE IN TAIWAN

190312 LOT 120319

S10102000B

CONSTRUCTION SCREW



U² FASTENERS™

10 X 2"1/2



U2 FASTENERS™
870 TUNGSTEN ST
THUNDER BAY, ON
P7B 6J3 CANADA



1,000 PCS
Approx. 13 lbs.



TIGHT STAR RECESS
NO STRIPPING



TAKES A T-25 U-BIT

WASHER HEAD WITH
TALON GRIP



FRAMING

REAMER THREAD



INTERIOR / EXTERIOR USE

TAPPER POINT
NO PREDRILLING



PATENT PENDING
MADE IN TAIWAN

190312 LOT 120319

S10102500B

CONSTRUCTION SCREW



U² FASTENERS™

10 X 2"1/2



U2 FASTENERS™
870 TUNGSTEN ST
THUNDER BAY, ON
P7B 6J3 CANADA



1,000 PCS
Approx. 13 lbs.



TIGHT STAR RECESS
NO STRIPPING



TAKES A T-25 U-BIT

WASHER HEAD WITH
TALON GRIP



FRAMING

REAMER THREAD



INTERIOR / EXTERIOR USE

TAPPER POINT
NO PREDRILLING



PATENT PENDING
MADE IN TAIWAN

190312 LOT 120319

S10102500B

CONSTRUCTION SCREW



U² FASTENERS™

10 X 2"3/4



U2 FASTENERS™
870 TUNGSTEN ST
THUNDER BAY, ON
P7B 6J3 CANADA



1,000 PCS
Approx. 14 lbs.



TIGHT STAR RECESS
NO STRIPPING



TAKES A T-25 U-BIT

WASHER HEAD WITH
TALON GRIP



FRAMING

REAMER THREAD



INTERIOR / EXTERIOR USE

TAPPER POINT
NO PREDRILLING



PATENT PENDING
MADE IN TAIWAN

190312 LOT 120319

S10102750B

CONSTRUCTION SCREW



U² FASTENERS™

10 X 2"3/4



U2 FASTENERS™
870 TUNGSTEN ST
THUNDER BAY, ON
P7B 6J3 CANADA



1,000 PCS
Approx. 14 lbs.



TIGHT STAR RECESS
NO STRIPPING



TAKES A T-25 U-BIT

WASHER HEAD WITH
TALON GRIP



FRAMING

REAMER THREAD



INTERIOR / EXTERIOR USE

TAPPER POINT
NO PREDRILLING



PATENT PENDING
MADE IN TAIWAN

190312 LOT 120319

S10102750B

CONSTRUCTION SCREW



U² FASTENERS™

10 X 3"1/8



U2 FASTENERS™
870 TUNGSTEN ST
THUNDER BAY, ON
P7B 6J3 CANADA



800 PCS
Approx. 12 lbs.



TIGHT STAR RECESS
NO STRIPPING



TAKES A T-25 U-BIT

WASHER HEAD WITH
TALON GRIP



FRAMING

REAMER THREAD



INTERIOR / EXTERIOR USE

TAPPER POINT
NO PREDRILLING



PATENT PENDING
MADE IN TAIWAN

190312 LOT 120319

S10103125B

CONSTRUCTION SCREW



U² FASTENERS™

10 X 3"1/8



U2 FASTENERS™
870 TUNGSTEN ST
THUNDER BAY, ON
P7B 6J3 CANADA



800 PCS
Approx. 12 lbs.



TIGHT STAR RECESS
NO STRIPPING



TAKES A T-25 U-BIT

WASHER HEAD WITH
TALON GRIP



FRAMING

REAMER THREAD



INTERIOR / EXTERIOR USE

TAPPER POINT
NO PREDRILLING



PATENT PENDING
MADE IN TAIWAN

190312 LOT 120319

S10103125B

CONSTRUCTION SCREW



U² FASTENERS™

1/4 X 1"1/2



U2 FASTENERS™
870 TUNGSTEN ST
THUNDER BAY, ON
P7B 6J3 CANADA



1,000 PCS
Approx. 14 lbs.



TIGHT STAR RECESS
NO STRIPPING



TAKES A T-25 U-BIT

WASHER HEAD WITH
TALON GRIP



FRAMING

L- SHAPED CUTTING
TEETH



INTERIOR / EXTERIOR USE

TAPPER POINT
NO PREDRILLING



PATENT PENDING
MADE IN TAIWAN

190312 LOT 120319

S14101500B

CONSTRUCTION SCREW



U² FASTENERS™

1/4 X 1"1/2



U2 FASTENERS™
870 TUNGSTEN ST
THUNDER BAY, ON
P7B 6J3 CANADA



1,000 PCS
Approx. 14 lbs.



TIGHT STAR RECESS
NO STRIPPING



TAKES A T-25 U-BIT

WASHER HEAD WITH
TALON GRIP



FRAMING

L- SHAPED CUTTING
TEETH



INTERIOR / EXTERIOR USE

TAPPER POINT
NO PREDRILLING



PATENT PENDING
MADE IN TAIWAN

190312 LOT 120319

S14101500B

CONSTRUCTION SCREW





1/4 X 2"



U2 FASTENERS™
870 TUNGSTEN ST
THUNDER BAY, ON
P7B 6J3 CANADA

800 PCS
Approx. 13 lbs.



TIGHT STAR RECESS
NO STRIPPING



TAKES A T-25 U-BIT

WASHER HEAD WITH
TALON GRIP



FRAMING

L- SHAPED CUTTING
TEETH



INTERIOR / EXTERIOR USE

TAPPER POINT
NO PREDRILLING



PATENT PENDING
MADE IN TAIWAN

190312 LOT 120319

S14102000B

CONSTRUCTION SCREW



1/4 X 2"



U2 FASTENERS™
870 TUNGSTEN ST
THUNDER BAY, ON
P7B 6J3 CANADA

800 PCS
Approx. 13 lbs.



TIGHT STAR RECESS
NO STRIPPING



TAKES A T-25 U-BIT

WASHER HEAD WITH
TALON GRIP



FRAMING

L- SHAPED CUTTING
TEETH



INTERIOR / EXTERIOR USE

TAPPER POINT
NO PREDRILLING



PATENT PENDING
MADE IN TAIWAN

190312 LOT 120319

S14102000B

CONSTRUCTION SCREW



U² FASTENERS™

1/4 X 2"1/2



U2 FASTENERS™
870 TUNGSTEN ST
THUNDER BAY, ON
P7B 6J3 CANADA



700 PCS
Approx. 13 lbs.



TIGHT STAR RECESS
NO STRIPPING



TAKES A T-25 U-BIT

WASHER HEAD WITH
TALON GRIP



FRAMING

REAMER THREAD



INTERIOR / EXTERIOR USE

TAPPER POINT
NO PREDRILLING



PATENT PENDING
MADE IN TAIWAN

190312 LOT 120319

S14102500B

CONSTRUCTION SCREW



U² FASTENERS™

1/4 X 2"1/2



U2 FASTENERS™
870 TUNGSTEN ST
THUNDER BAY, ON
P7B 6J3 CANADA



700 PCS
Approx. 13 lbs.



TIGHT STAR RECESS
NO STRIPPING



TAKES A T-25 U-BIT

WASHER HEAD WITH
TALON GRIP



FRAMING

REAMER THREAD



INTERIOR / EXTERIOR USE

TAPPER POINT
NO PREDRILLING



PATENT PENDING
MADE IN TAIWAN

190312 LOT 120319

S14102500B

CONSTRUCTION SCREW



U² FASTENERS™

1/4 X 3"1/8



U2 FASTENERS™
870 TUNGSTEN ST
THUNDER BAY, ON
P7B 6J3 CANADA



500 PCS
Approx. 16 lbs.



TIGHT STAR RECESS
NO STRIPPING



TAKES A T-25 U-BIT

WASHER HEAD WITH
TALON GRIP



FRAMING

REAMER THREAD



INTERIOR / EXTERIOR USE

TAPPER POINT
NO PREDRILLING



PATENT PENDING
MADE IN TAIWAN

190312 LOT 120319

S14103125B

CONSTRUCTION SCREW



U² FASTENERS™

1/4 X 3"1/8



U2 FASTENERS™
870 TUNGSTEN ST
THUNDER BAY, ON
P7B 6J3 CANADA



500 PCS
Approx. 16 lbs.



TIGHT STAR RECESS
NO STRIPPING



TAKES A T-25 U-BIT

WASHER HEAD WITH
TALON GRIP



FRAMING

REAMER THREAD



INTERIOR / EXTERIOR USE

TAPPER POINT
NO PREDRILLING



PATENT PENDING
MADE IN TAIWAN

190312 LOT 120319

S14103125B

CONSTRUCTION SCREW





1/4 x 3"3/8



U2 FASTENERS™
870 TUNGSTEN ST
THUNDER BAY, ON
P7B 6J3 CANADA

400 PCS
Approx. 10 lbs.



TIGHT STAR RECESS
NO STRIPPING



TAKES A T-25 U-BIT

WASHER HEAD WITH
TALON GRIP



FRAMING

REAMER THREAD



INTERIOR / EXTERIOR USE

TAPPER POINT
NO PREDRILLING



PATENT PENDING
MADE IN TAIWAN

190312 LOT 120319

S14103375B

CONSTRUCTION SCREW



1/4 x 3"3/8



U2 FASTENERS™
870 TUNGSTEN ST
THUNDER BAY, ON
P7B 6J3 CANADA

400 PCS
Approx. 10 lbs.



TIGHT STAR RECESS
NO STRIPPING



TAKES A T-25 U-BIT

WASHER HEAD WITH
TALON GRIP



FRAMING

REAMER THREAD



INTERIOR / EXTERIOR USE

TAPPER POINT
NO PREDRILLING



PATENT PENDING
MADE IN TAIWAN

190312 LOT 120319

S14103375B

CONSTRUCTION SCREW



U² FASTENERS™

5/16 X 2"1/2



U2 FASTENERS™
870 TUNGSTEN ST
THUNDER BAY, ON
P7B 6J3 CANADA



600 PCS
Approx. 16 lbs.



TIGHT STAR RECESS
NO STRIPPING



TAKES A T-30 U-BIT

WASHER HEAD WITH
TALON GRIP



FRAMING

REAMER THREAD



INTERIOR / EXTERIOR USE

TAPPER POINT
NO PREDRILLING



PATENT PENDING
MADE IN TAIWAN

190312 LOT 120319

S20102500B

CONSTRUCTION SCREW



U² FASTENERS™

5/16 X 2"1/2



U2 FASTENERS™
870 TUNGSTEN ST
THUNDER BAY, ON
P7B 6J3 CANADA



600 PCS
Approx. 16 lbs.



TIGHT STAR RECESS
NO STRIPPING



TAKES A T-30 U-BIT

WASHER HEAD WITH
TALON GRIP



FRAMING

REAMER THREAD



INTERIOR / EXTERIOR USE

TAPPER POINT
NO PREDRILLING



PATENT PENDING
MADE IN TAIWAN

190312 LOT 120319

S20102500B

CONSTRUCTION SCREW



U² FASTENERS™

5/16 X 3"1/8



U2 FASTENERS™
870 TUNGSTEN ST
THUNDER BAY, ON
P7B 6J3 CANADA



500 PCS
Approx. 16 lbs.



TIGHT STAR RECESS
NO STRIPPING



TAKES A T-30 U-BIT

WASHER HEAD WITH
TALON GRIP



FRAMING

REAMER THREAD



INTERIOR / EXTERIOR USE

TAPPER POINT
NO PREDRILLING



PATENT PENDING
MADE IN TAIWAN

190312 LOT 120319

S20103125B

CONSTRUCTION SCREW



U² FASTENERS™

5/16 X 3"1/8



U2 FASTENERS™
870 TUNGSTEN ST
THUNDER BAY, ON
P7B 6J3 CANADA



500 PCS
Approx. 16 lbs.



TIGHT STAR RECESS
NO STRIPPING



TAKES A T-30 U-BIT

WASHER HEAD WITH
TALON GRIP



FRAMING

REAMER THREAD



INTERIOR / EXTERIOR USE

TAPPER POINT
NO PREDRILLING



PATENT PENDING
MADE IN TAIWAN

190312 LOT 120319

S20103125B

CONSTRUCTION SCREW





5/16 X 4"



U2 FASTENERS™
870 TUNGSTEN ST
THUNDER BAY, ON
P7B 6J3 CANADA

400 PCS

Approx. 16 lbs.



TIGHT STAR RECESS
NO STRIPPING



TAKES A T-30 U-BIT

WASHER HEAD WITH
TALON GRIP



FRAMING

REAMER THREAD



INTERIOR / EXTERIOR USE

TAPPER POINT
NO PREDRILLING



PATENT PENDING
MADE IN TAIWAN

190312 LOT 120319

S20104000B

CONSTRUCTION SCREW



5/16 X 4"



U2 FASTENERS™
870 TUNGSTEN ST
THUNDER BAY, ON
P7B 6J3 CANADA

400 PCS

Approx. 16 lbs.



TIGHT STAR RECESS
NO STRIPPING



TAKES A T-30 U-BIT

WASHER HEAD WITH
TALON GRIP



FRAMING

REAMER THREAD



INTERIOR / EXTERIOR USE

TAPPER POINT
NO PREDRILLING



PATENT PENDING
MADE IN TAIWAN

190312 LOT 120319

S20104000B

CONSTRUCTION SCREW





5/16 X 5"



U2 FASTENERS™
870 TUNGSTEN ST
THUNDER BAY, ON
P7B 6J3 CANADA

300 PCS
Approx. 14 lbs.



TIGHT STAR RECESS
NO STRIPPING



TAKES A T- 30 U-BIT

WASHER HEAD WITH
TALON GRIP



FRAMING

REAMER THREAD



INTERIOR / EXTERIOR USE

TAPPER POINT
NO PREDRILLING



PATENT PENDING
MADE IN TAIWAN

190312 LOT 120319

S20105000B

CONSTRUCTION SCREW



5/16 X 5"



U2 FASTENERS™
870 TUNGSTEN ST
THUNDER BAY, ON
P7B 6J3 CANADA

300 PCS
Approx. 14 lbs.



TIGHT STAR RECESS
NO STRIPPING



TAKES A T- 30 U-BIT

WASHER HEAD WITH
TALON GRIP



FRAMING

REAMER THREAD



INTERIOR / EXTERIOR USE

TAPPER POINT
NO PREDRILLING



PATENT PENDING
MADE IN TAIWAN

190312 LOT 120319

S20105000B

CONSTRUCTION SCREW





5/16 X 6"



U2 FASTENERS™
870 TUNGSTEN ST
THUNDER BAY, ON
P7B 6J3 CANADA

300 PCS
Approx. 17 lbs.



TIGHT STAR RECESS
NO STRIPPING



TAKES A T- 30 U-BIT



WASHER HEAD WITH
TALON GRIP

FRAMING



REAMER THREAD

INTERIOR / EXTERIOR USE



TAPPER POINT
NO PREDRILLING

PATENT PENDING
MADE IN TAIWAN

190312 LOT 120319

S2010600B

CONSTRUCTION SCREW



5/16 X 6"



U2 FASTENERS™
870 TUNGSTEN ST
THUNDER BAY, ON
P7B 6J3 CANADA

300 PCS
Approx. 17 lbs.



TIGHT STAR RECESS
NO STRIPPING



TAKES A T- 30 U-BIT



WASHER HEAD WITH
TALON GRIP

FRAMING



REAMER THREAD

INTERIOR / EXTERIOR USE



TAPPER POINT
NO PREDRILLING

PATENT PENDING
MADE IN TAIWAN

190312 LOT 120319

S2010600B

CONSTRUCTION SCREW





3/8 X 3"1/8



U2 FASTENERS™
870 TUNGSTEN ST
THUNDER BAY, ON
P7B 6J3 CANADA

300 PCS
Approx. 13 lbs.



TIGHT STAR RECESS
NO STRIPPING



TAKES A T- 40 U-BIT



WASHER HEAD WITH
TALON GRIP

FRAMING



REAMER THREAD

INTERIOR / EXTERIOR USE



TAPPER POINT
NO PREDRILLING

PATENT PENDING
MADE IN TAIWAN

190312 LOT 120319

S22103125B

CONSTRUCTION SCREW



3/8 X 3"1/8



U2 FASTENERS™
870 TUNGSTEN ST
THUNDER BAY, ON
P7B 6J3 CANADA

300 PCS
Approx. 13 lbs.



TIGHT STAR RECESS
NO STRIPPING



TAKES A T- 40 U-BIT



WASHER HEAD WITH
TALON GRIP

FRAMING



REAMER THREAD

INTERIOR / EXTERIOR USE



TAPPER POINT
NO PREDRILLING

PATENT PENDING
MADE IN TAIWAN

190312 LOT 120319

S22103125B

CONSTRUCTION SCREW





3/8 X 3"3/8



U2 FASTENERS™
870 TUNGSTEN ST
THUNDER BAY, ON
P7B 6J3 CANADA

300 PCS
Approx. 14 lbs.



TIGHT STAR RECESS
NO STRIPPING



TAKES A T- 40 U-BIT

WASHER HEAD WITH
TALON GRIP



FRAMING

REAMER THREAD



INTERIOR / EXTERIOR USE

TAPPER POINT
NO PREDRILLING



PATENT PENDING
MADE IN TAIWAN

190312 LOT 120319

S22103375B

CONSTRUCTION SCREW



3/8 X 3"3/8



U2 FASTENERS™
870 TUNGSTEN ST
THUNDER BAY, ON
P7B 6J3 CANADA

300 PCS
Approx. 14 lbs.



TIGHT STAR RECESS
NO STRIPPING



TAKES A T- 40 U-BIT

WASHER HEAD WITH
TALON GRIP



FRAMING

REAMER THREAD



INTERIOR / EXTERIOR USE

TAPPER POINT
NO PREDRILLING



PATENT PENDING
MADE IN TAIWAN

190312 LOT 120319

S22103375B

CONSTRUCTION SCREW





3/8 X 4"



U2 FASTENERS™
870 TUNGSTEN ST
THUNDER BAY, ON
P7B 6J3 CANADA

300 PCS
Approx. 15 lbs.



TIGHT STAR RECESS
NO STRIPPING



TAKES A T- 40 U-BIT



WASHER HEAD WITH
TALON GRIP

FRAMING



REAMER THREAD

INTERIOR / EXTERIOR USE



TAPPER POINT
NO PREDRILLING

PATENT PENDING
MADE IN TAIWAN

190312 LOT 120319

S22104000B

CONSTRUCTION SCREW



3/8 X 4"



U2 FASTENERS™
870 TUNGSTEN ST
THUNDER BAY, ON
P7B 6J3 CANADA

300 PCS
Approx. 15 lbs.



TIGHT STAR RECESS
NO STRIPPING



TAKES A T- 40 U-BIT



WASHER HEAD WITH
TALON GRIP

FRAMING



REAMER THREAD

INTERIOR / EXTERIOR USE



TAPPER POINT
NO PREDRILLING

PATENT PENDING
MADE IN TAIWAN

190312 LOT 120319

S22104000B

CONSTRUCTION SCREW





3/8 X 5"



U2 FASTENERS™
870 TUNGSTEN ST
THUNDER BAY, ON
P7B 6J3 CANADA

300 PCS
Approx. 19 lbs.



TIGHT STAR RECESS
NO STRIPPING



TAKES A T- 40 U-BIT



WASHER HEAD WITH
TALON GRIP

FRAMING



REAMER THREAD

INTERIOR / EXTERIOR USE



TAPPER POINT
NO PREDRILLING

PATENT PENDING
MADE IN TAIWAN

190312 LOT 120319

S22105000B

CONSTRUCTION SCREW



3/8 X 5"



U2 FASTENERS™
870 TUNGSTEN ST
THUNDER BAY, ON
P7B 6J3 CANADA

300 PCS
Approx. 19 lbs.



TIGHT STAR RECESS
NO STRIPPING



TAKES A T- 40 U-BIT



WASHER HEAD WITH
TALON GRIP

FRAMING



REAMER THREAD

INTERIOR / EXTERIOR USE



TAPPER POINT
NO PREDRILLING

PATENT PENDING
MADE IN TAIWAN

190312 LOT 120319

S22105000B

CONSTRUCTION SCREW





3/8 X 6"



U2 FASTENERS™
870 TUNGSTEN ST
THUNDER BAY, ON
P7B 6J3 CANADA

300 PCS

Approx. 22 lbs.



TIGHT STAR RECESS
NO STRIPPING



TAKES A T-40 U-BIT



WASHER HEAD WITH
TALON GRIP

FRAMING



REAMER THREAD

INTERIOR / EXTERIOR USE



TAPPER POINT
NO PREDRILLING

PATENT PENDING
MADE IN TAIWAN

190312 LOT 120319

S2210600B

CONSTRUCTION SCREW



3/8 X 6"



U2 FASTENERS™
870 TUNGSTEN ST
THUNDER BAY, ON
P7B 6J3 CANADA

300 PCS

Approx. 22 lbs.



TIGHT STAR RECESS
NO STRIPPING



TAKES A T-40 U-BIT



WASHER HEAD WITH
TALON GRIP

FRAMING



REAMER THREAD

INTERIOR / EXTERIOR USE



TAPPER POINT
NO PREDRILLING

PATENT PENDING
MADE IN TAIWAN

190312 LOT 120319

S2210600B

CONSTRUCTION SCREW





3/8 X 6"3/4



U2 FASTENERS™
870 TUNGSTEN ST
THUNDER BAY, ON
P7B 6J3 CANADA

300 PCS
Approx. 26 lbs.



TIGHT STAR RECESS
NO STRIPPING



TAKES A T- 40 U-BIT

WASHER HEAD WITH
TALON GRIP



FRAMING

REAMER THREAD



INTERIOR / EXTERIOR USE

TAPPER POINT
NO PREDRILLING



PATENT PENDING
MADE IN TAIWAN

190312 LOT 120319

S22106750B

CONSTRUCTION SCREW



3/8 X 6"3/4



U2 FASTENERS™
870 TUNGSTEN ST
THUNDER BAY, ON
P7B 6J3 CANADA

300 PCS
Approx. 26 lbs.



TIGHT STAR RECESS
NO STRIPPING



TAKES A T- 40 U-BIT

WASHER HEAD WITH
TALON GRIP



FRAMING

REAMER THREAD



INTERIOR / EXTERIOR USE

TAPPER POINT
NO PREDRILLING



PATENT PENDING
MADE IN TAIWAN

190312 LOT 120319

S22106750B

CONSTRUCTION SCREW





3/8 X 7"



U2 FASTENERS™
870 TUNGSTEN ST
THUNDER BAY, ON
P7B 6J3 CANADA

300 PCS

Approx. 26 lbs.



TIGHT STAR RECESS
NO STRIPPING



TAKES A T-40 U-BIT



WASHER HEAD WITH
TALON GRIP

FRAMING



REAMER THREAD

INTERIOR / EXTERIOR USE



TAPPER POINT
NO PREDRILLING

PATENT PENDING
MADE IN TAIWAN

190312 LOT 120319

S22107000B

CONSTRUCTION SCREW



3/8 X 7"



U2 FASTENERS™
870 TUNGSTEN ST
THUNDER BAY, ON
P7B 6J3 CANADA

300 PCS

Approx. 26 lbs.



TIGHT STAR RECESS
NO STRIPPING



TAKES A T-40 U-BIT



WASHER HEAD WITH
TALON GRIP

FRAMING



REAMER THREAD

INTERIOR / EXTERIOR USE



TAPPER POINT
NO PREDRILLING

PATENT PENDING
MADE IN TAIWAN

190312 LOT 120319

S22107000B

CONSTRUCTION SCREW





3/8 X 8"



U2 FASTENERS™
870 TUNGSTEN ST
THUNDER BAY, ON
P7B 6J3 CANADA

300 PCS
Approx. 29 lbs.



TIGHT STAR RECESS
NO STRIPPING



TAKES A T- 40 U-BIT



WASHER HEAD WITH
TALON GRIP

FRAMING



REAMER THREAD

INTERIOR / EXTERIOR USE



TAPPER POINT
NO PREDRILLING

PATENT PENDING
MADE IN TAIWAN

190312 LOT 120319

S22108000B

CONSTRUCTION SCREW



3/8 X 8"



U2 FASTENERS™
870 TUNGSTEN ST
THUNDER BAY, ON
P7B 6J3 CANADA

300 PCS
Approx. 29 lbs.



TIGHT STAR RECESS
NO STRIPPING



TAKES A T- 40 U-BIT



WASHER HEAD WITH
TALON GRIP

FRAMING



REAMER THREAD

INTERIOR / EXTERIOR USE



TAPPER POINT
NO PREDRILLING

PATENT PENDING
MADE IN TAIWAN

190312 LOT 120319

S22108000B

CONSTRUCTION SCREW





3/8 X 10"



U2 FASTENERS™
870 TUNGSTEN ST
THUNDER BAY, ON
P7B 6J3 CANADA

300 PCS
Approx. 36 lbs.



TIGHT STAR RECESS
NO STRIPPING



TAKES A T- 40 U-BIT

WASHER HEAD WITH
TALON GRIP



FRAMING

REAMER THREAD



INTERIOR / EXTERIOR USE

TAPPER POINT
NO PREDRILLING



PATENT PENDING
MADE IN TAIWAN

190312 LOT 120319

S2211000B

CONSTRUCTION SCREW



3/8 X 10"



U2 FASTENERS™
870 TUNGSTEN ST
THUNDER BAY, ON
P7B 6J3 CANADA

300 PCS
Approx. 36 lbs.



TIGHT STAR RECESS
NO STRIPPING



TAKES A T- 40 U-BIT

WASHER HEAD WITH
TALON GRIP



FRAMING

REAMER THREAD



INTERIOR / EXTERIOR USE

TAPPER POINT
NO PREDRILLING



PATENT PENDING
MADE IN TAIWAN

190312 LOT 120319

S2211000B

CONSTRUCTION SCREW





3/8 X 12"



U2 FASTENERS™
870 TUNGSTEN ST
THUNDER BAY, ON
P7B 6J3 CANADA

300 PCS
Approx. 43 lbs.



TIGHT STAR RECESS
NO STRIPPING



TAKES A T- 40 U-BIT



WASHER HEAD WITH
TALON GRIP

FRAMING



REAMER THREAD

INTERIOR / EXTERIOR USE



TAPPER POINT
NO PREDRILLING

PATENT PENDING
MADE IN TAIWAN

190312 LOT 120319

S22112000B

CONSTRUCTION SCREW



3/8 X 12"



U2 FASTENERS™
870 TUNGSTEN ST
THUNDER BAY, ON
P7B 6J3 CANADA

300 PCS
Approx. 43 lbs.



TIGHT STAR RECESS
NO STRIPPING



TAKES A T- 40 U-BIT



WASHER HEAD WITH
TALON GRIP

FRAMING



REAMER THREAD

INTERIOR / EXTERIOR USE



TAPPER POINT
NO PREDRILLING

PATENT PENDING
MADE IN TAIWAN

190312 LOT 120319

S22112000B

CONSTRUCTION SCREW





3/8 X 14"



U2 FASTENERS™
870 TUNGSTEN ST
THUNDER BAY, ON
P7B 6J3 CANADA

300 PCS
Approx. 50 lbs.



TIGHT STAR RECESS
NO STRIPPING



TAKES A T- 40 U-BIT



WASHER HEAD WITH
TALON GRIP

FRAMING



REAMER THREAD

INTERIOR / EXTERIOR USE



TAPPER POINT
NO PREDRILLING

PATENT PENDING
MADE IN TAIWAN

190312 LOT 120319

S22114000B

CONSTRUCTION SCREW



3/8 X 14"



U2 FASTENERS™
870 TUNGSTEN ST
THUNDER BAY, ON
P7B 6J3 CANADA

300 PCS
Approx. 50 lbs.



TIGHT STAR RECESS
NO STRIPPING



TAKES A T- 40 U-BIT



WASHER HEAD WITH
TALON GRIP

FRAMING



REAMER THREAD

INTERIOR / EXTERIOR USE



TAPPER POINT
NO PREDRILLING

PATENT PENDING
MADE IN TAIWAN

190312 LOT 120319

S22114000B

CONSTRUCTION SCREW





3/8 X 16"



U2 FASTENERS™
870 TUNGSTEN ST
THUNDER BAY, ON
P7B 6J3 CANADA

80 PCS

Approx. 15 lbs.



TIGHT STAR RECESS
NO STRIPPING



TAKES A T- 40 U-BIT



WASHER HEAD WITH
TALON GRIP

FRAMING



REAMER THREAD

INTERIOR / EXTERIOR USE



TAPPER POINT
NO PREDRILLING

PATENT PENDING
MADE IN TAIWAN

190312 LOT 120319

S2211600B

CONSTRUCTION SCREW



3/8 X 16"



U2 FASTENERS™
870 TUNGSTEN ST
THUNDER BAY, ON
P7B 6J3 CANADA

80 PCS

Approx. 15 lbs.



TIGHT STAR RECESS
NO STRIPPING



TAKES A T- 40 U-BIT



WASHER HEAD WITH
TALON GRIP

FRAMING



REAMER THREAD

INTERIOR / EXTERIOR USE



TAPPER POINT
NO PREDRILLING

PATENT PENDING
MADE IN TAIWAN

190312 LOT 120319

S2211600B

CONSTRUCTION SCREW





3/8 X 20"



U2 FASTENERS™
870 TUNGSTEN ST
THUNDER BAY, ON
P7B 6J3 CANADA

100 PCS
Approx. 23 lbs.



TIGHT STAR RECESS
NO STRIPPING



TAKES A T- 40 U-BIT



WASHER HEAD WITH
TALON GRIP

FRAMING



REAMER THREAD

INTERIOR / EXTERIOR USE



TYPE 17 POINT
NO PREDRILLING

PATENT PENDING
MADE IN TAIWAN

190312 LOT 120319

S2212000B

CONSTRUCTION SCREW



3/8 X 20"



U2 FASTENERS™
870 TUNGSTEN ST
THUNDER BAY, ON
P7B 6J3 CANADA

100 PCS
Approx. 23 lbs.



TIGHT STAR RECESS
NO STRIPPING



TAKES A T- 40 U-BIT



WASHER HEAD WITH
TALON GRIP

FRAMING



REAMER THREAD

INTERIOR / EXTERIOR USE



TYPE 17 POINT
NO PREDRILLING

PATENT PENDING
MADE IN TAIWAN

190312 LOT 120319

S2212000B

CONSTRUCTION SCREW





6 X 1"1/2



U2 FASTENERS™
870 TUNGSTEN ST
THUNDER BAY, ON
P7B 6J3 CANADA

8,000 PCS
Approx. 31 lbs.



TIGHT STAR RECESS
NO STRIPPING



TAKES A T-15 U-BIT

BURROW POCKETS



COUNTERSINK HEAD

L- SHAPED CUTTING
TEETH



INTERIOR / EXTERIOR USE

TAPPER POINT
NO PREDRILLING



PATENT PENDING
MADE IN TAIWAN

190312 LOT 120319

U06101500B

UNIVERSAL SCREW



6 X 1"1/2



U2 FASTENERS™
870 TUNGSTEN ST
THUNDER BAY, ON
P7B 6J3 CANADA

8,000 PCS
Approx. 31 lbs.



TIGHT STAR RECESS
NO STRIPPING



TAKES A T-15 U-BIT

BURROW POCKETS



COUNTERSINK HEAD

L- SHAPED CUTTING
TEETH



INTERIOR / EXTERIOR USE

TAPPER POINT
NO PREDRILLING



PATENT PENDING
MADE IN TAIWAN

190312 LOT 120319

U06101500B

UNIVERSAL SCREW





8 X 1"1/4



U2 FASTENERS™
870 TUNGSTEN ST
THUNDER BAY, ON
P7B 6J3 CANADA

10,000 PCS
Approx. 41 lbs.



TIGHT STAR RECESS
NO STRIPPING



TAKES A T-15 U-BIT

BURROW POCKETS



COUNTERSINK HEAD

L- SHAPED CUTTING
TEETH



INTERIOR / EXTERIOR USE

TAPPER POINT
NO PREDRILLING



PATENT PENDING
MADE IN TAIWAN

190312 LOT 120319

U08101250B

UNIVERSAL SCREW



8 X 1"1/4



U2 FASTENERS™
870 TUNGSTEN ST
THUNDER BAY, ON
P7B 6J3 CANADA

10,000 PCS
Approx. 41 lbs.



TIGHT STAR RECESS
NO STRIPPING



TAKES A T-15 U-BIT

BURROW POCKETS



COUNTERSINK HEAD

L- SHAPED CUTTING
TEETH



INTERIOR / EXTERIOR USE

TAPPER POINT
NO PREDRILLING



PATENT PENDING
MADE IN TAIWAN

190312 LOT 120319

U08101250B

UNIVERSAL SCREW





8 X 1"1/2



U2 FASTENERS™
870 TUNGSTEN ST
THUNDER BAY, ON
P7B 6J3 CANADA

6,500 PCS
Approx. 30 lbs.



TIGHT STAR RECESS
NO STRIPPING



TAKES A T-15 U-BIT

BURROW POCKETS



COUNTERSINK HEAD

L- SHAPED CUTTING
TEETH



INTERIOR / EXTERIOR USE

TAPPER POINT
NO PREDRILLING



PATENT PENDING
MADE IN TAIWAN

190312 LOT 120319

U08101500B

UNIVERSAL SCREW



8 X 1"1/2



U2 FASTENERS™
870 TUNGSTEN ST
THUNDER BAY, ON
P7B 6J3 CANADA

6,500 PCS
Approx. 30 lbs.



TIGHT STAR RECESS
NO STRIPPING



TAKES A T-15 U-BIT

BURROW POCKETS



COUNTERSINK HEAD

L- SHAPED CUTTING
TEETH



INTERIOR / EXTERIOR USE

TAPPER POINT
NO PREDRILLING



PATENT PENDING
MADE IN TAIWAN

190312 LOT 120319

U08101500B

UNIVERSAL SCREW





8 X 2"



U2 FASTENERS™
870 TUNGSTEN ST
THUNDER BAY, ON
P7B 6J3 CANADA

4,500 PCS
Approx. 27 lbs.



TIGHT STAR RECESS
NO STRIPPING



TAKES A T-15 U-BIT

BURROW POCKETS



COUNTERSINK HEAD

REAMER THREAD



INTERIOR / EXTERIOR USE

TAPPER POINT
NO PREDRILLING



PATENT PENDING
MADE IN TAIWAN

190312 LOT 120319

U08102000B

UNIVERSAL SCREW



8 X 2"



U2 FASTENERS™
870 TUNGSTEN ST
THUNDER BAY, ON
P7B 6J3 CANADA

4,500 PCS
Approx. 27 lbs.



TIGHT STAR RECESS
NO STRIPPING



TAKES A T-15 U-BIT

BURROW POCKETS



COUNTERSINK HEAD

REAMER THREAD



INTERIOR / EXTERIOR USE

TAPPER POINT
NO PREDRILLING



PATENT PENDING
MADE IN TAIWAN

190312 LOT 120319

U08102000B

UNIVERSAL SCREW





9 X 1"1/2



U2 FASTENERS™
870 TUNGSTEN ST
THUNDER BAY, ON
P7B 6J3 CANADA

5,200 PCS
Approx. 29 lbs.



TIGHT STAR RECESS
NO STRIPPING



TAKES A T-25 U-BIT

BURROW POCKETS



COUNTERSINK HEAD

L- SHAPED CUTTING
TEETH



INTERIOR / EXTERIOR USE

TAPPER POINT
NO PREDRILLING



PATENT PENDING
MADE IN TAIWAN

190312 LOT 120319

U09101500B

UNIVERSAL SCREW



9 X 1"1/2



U2 FASTENERS™
870 TUNGSTEN ST
THUNDER BAY, ON
P7B 6J3 CANADA

5,200 PCS
Approx. 29 lbs.



TIGHT STAR RECESS
NO STRIPPING



TAKES A T-25 U-BIT

BURROW POCKETS



COUNTERSINK HEAD

L- SHAPED CUTTING
TEETH



INTERIOR / EXTERIOR USE

TAPPER POINT
NO PREDRILLING



PATENT PENDING
MADE IN TAIWAN

190312 LOT 120319

U09101500B

UNIVERSAL SCREW





9 X 1"3/4



U2 FASTENERS™
870 TUNGSTEN ST
THUNDER BAY, ON
P7B 6J3 CANADA

4,500 PCS
Approx. 31 lbs.



TIGHT STAR RECESS
NO STRIPPING



TAKES A T-25 U-BIT

BURROW POCKETS



COUNTERSINK HEAD

L- SHAPED CUTTING
TEETH



INTERIOR / EXTERIOR USE

TAPPER POINT
NO PREDRILLING



PATENT PENDING
MADE IN TAIWAN

190312 LOT 120319

U09101750B

UNIVERSAL SCREW



9 X 1"3/4



U2 FASTENERS™
870 TUNGSTEN ST
THUNDER BAY, ON
P7B 6J3 CANADA

4,500 PCS
Approx. 31 lbs.



TIGHT STAR RECESS
NO STRIPPING



TAKES A T-25 U-BIT

BURROW POCKETS



COUNTERSINK HEAD

L- SHAPED CUTTING
TEETH



INTERIOR / EXTERIOR USE

TAPPER POINT
NO PREDRILLING



PATENT PENDING
MADE IN TAIWAN

190312 LOT 120319

U09101750B

UNIVERSAL SCREW





9 X 2"



U2 FASTENERS™
870 TUNGSTEN ST
THUNDER BAY, ON
P7B 6J3 CANADA

3,700 PCS
Approx. 28 lbs.



TIGHT STAR RECESS
NO STRIPPING



TAKES A T-25 U-BIT

BURROW POCKETS



COUNTERSINK HEAD

REAMER THREAD



INTERIOR / EXTERIOR USE

TAPPER POINT
NO PREDRILLING



PATENT PENDING
MADE IN TAIWAN

190312 LOT 120319

U09102000B

UNIVERSAL SCREW



9 X 2"



U2 FASTENERS™
870 TUNGSTEN ST
THUNDER BAY, ON
P7B 6J3 CANADA

3,700 PCS
Approx. 28 lbs.



TIGHT STAR RECESS
NO STRIPPING



TAKES A T-25 U-BIT

BURROW POCKETS



COUNTERSINK HEAD

REAMER THREAD



INTERIOR / EXTERIOR USE

TAPPER POINT
NO PREDRILLING



PATENT PENDING
MADE IN TAIWAN

190312 LOT 120319

U09102000B

UNIVERSAL SCREW





9 X 2"1/2



U2 FASTENERS™
870 TUNGSTEN ST
THUNDER BAY, ON
P7B 6J3 CANADA

2,600 PCS
Approx. 25 lbs.



TIGHT STAR RECESS
NO STRIPPING



TAKES A T-25 U-BIT

BURROW POCKETS



COUNTERSINK HEAD

REAMER THREAD



INTERIOR / EXTERIOR USE

TAPPER POINT
NO PREDRILLING



PATENT PENDING
MADE IN TAIWAN

190312 LOT 120319

U09102500B

UNIVERSAL SCREW



9 X 2"1/2



U2 FASTENERS™
870 TUNGSTEN ST
THUNDER BAY, ON
P7B 6J3 CANADA

2,600 PCS
Approx. 25 lbs.



TIGHT STAR RECESS
NO STRIPPING



TAKES A T-25 U-BIT

BURROW POCKETS



COUNTERSINK HEAD

REAMER THREAD



INTERIOR / EXTERIOR USE

TAPPER POINT
NO PREDRILLING



PATENT PENDING
MADE IN TAIWAN

190312 LOT 120319

U09102500B

UNIVERSAL SCREW





9 X 2"3/4



U2 FASTENERS™
870 TUNGSTEN ST
THUNDER BAY, ON
P7B 6J3 CANADA

2,000 PCS
Approx. 20 lbs.



TIGHT STAR RECESS
NO STRIPPING



TAKES A T-25 U-BIT

BURROW POCKETS



COUNTERSINK HEAD

REAMER THREAD



INTERIOR / EXTERIOR USE

TAPPER POINT
NO PREDRILLING



PATENT PENDING
MADE IN TAIWAN

190312 LOT 120319

U09102750B

UNIVERSAL SCREW



9 X 2"3/4



U2 FASTENERS™
870 TUNGSTEN ST
THUNDER BAY, ON
P7B 6J3 CANADA

2,000 PCS
Approx. 20 lbs.



TIGHT STAR RECESS
NO STRIPPING



TAKES A T-25 U-BIT

BURROW POCKETS



COUNTERSINK HEAD

REAMER THREAD



INTERIOR / EXTERIOR USE

TAPPER POINT
NO PREDRILLING



PATENT PENDING
MADE IN TAIWAN

190312 LOT 120319

U09102750B

UNIVERSAL SCREW





9 X 3"1/8



U2 FASTENERS™
870 TUNGSTEN ST
THUNDER BAY, ON
P7B 6J3 CANADA

1,500 PCS
Approx. 17 lbs.



TIGHT STAR RECESS
NO STRIPPING



TAKES A T-25 U-BIT

BURROW POCKETS



COUNTERSINK HEAD

REAMER THREAD



INTERIOR / EXTERIOR USE

TAPPER POINT
NO PREDRILLING



PATENT PENDING
MADE IN TAIWAN

190312 LOT 120319

U09103125B

UNIVERSAL SCREW



9 X 3"1/8



U2 FASTENERS™
870 TUNGSTEN ST
THUNDER BAY, ON
P7B 6J3 CANADA

1,500 PCS
Approx. 17 lbs.



TIGHT STAR RECESS
NO STRIPPING



TAKES A T-25 U-BIT

BURROW POCKETS



COUNTERSINK HEAD

REAMER THREAD



INTERIOR / EXTERIOR USE

TAPPER POINT
NO PREDRILLING



PATENT PENDING
MADE IN TAIWAN

190312 LOT 120319

U09103125B

UNIVERSAL SCREW



U² FASTENERS™

10 X 1"5/8



U2 FASTENERS™
870 TUNGSTEN ST
THUNDER BAY, ON
P7B 6J3 CANADA



3,200 PCS
Approx. 25 lbs.



TIGHT STAR RECESS
NO STRIPPING



TAKES A T-25 U-BIT

BURROW POCKETS



COUNTERSINK HEAD

L- SHAPED CUTTING
TEETH



INTERIOR / EXTERIOR USE

TAPPER POINT
NO PREDRILLING



PATENT PENDING
MADE IN TAIWAN

190312 LOT 120319

U10101625B

UNIVERSAL SCREW



U² FASTENERS™

10 X 1"5/8



U2 FASTENERS™
870 TUNGSTEN ST
THUNDER BAY, ON
P7B 6J3 CANADA



3,200 PCS
Approx. 25 lbs.



TIGHT STAR RECESS
NO STRIPPING



TAKES A T-25 U-BIT

BURROW POCKETS



COUNTERSINK HEAD

L- SHAPED CUTTING
TEETH



INTERIOR / EXTERIOR USE

TAPPER POINT
NO PREDRILLING



PATENT PENDING
MADE IN TAIWAN

190312 LOT 120319

U10101625B

UNIVERSAL SCREW





10 X 2"1/4



U2 FASTENERS™
870 TUNGSTEN ST
THUNDER BAY, ON
P7B 6J3 CANADA

2,400 PCS
Approx. 26 lbs.



TIGHT STAR RECESS
NO STRIPPING



TAKES A T-25 U-BIT

BURROW POCKETS



COUNTERSINK HEAD

L- SHAPED CUTTING
TEETH



INTERIOR / EXTERIOR USE

TAPPER POINT
NO PREDRILLING



PATENT PENDING
MADE IN TAIWAN

190312 LOT 120319

U10102250B

UNIVERSAL SCREW



10 X 2"1/4



U2 FASTENERS™
870 TUNGSTEN ST
THUNDER BAY, ON
P7B 6J3 CANADA

2,400 PCS
Approx. 26 lbs.



TIGHT STAR RECESS
NO STRIPPING



TAKES A T-25 U-BIT

BURROW POCKETS



COUNTERSINK HEAD

L- SHAPED CUTTING
TEETH



INTERIOR / EXTERIOR USE

TAPPER POINT
NO PREDRILLING



PATENT PENDING
MADE IN TAIWAN

190312 LOT 120319

U10102250B

UNIVERSAL SCREW





10 X 2"1/2



U2 FASTENERS™
870 TUNGSTEN ST
THUNDER BAY, ON
P7B 6J3 CANADA

2,200 PCS
Approx. 26 lbs.



TIGHT STAR RECESS
NO STRIPPING



TAKES A T-25 U-BIT

BURROW POCKETS



COUNTERSINK HEAD

REAMER THREAD



INTERIOR / EXTERIOR USE

TAPPER POINT
NO PREDRILLING



PATENT PENDING
MADE IN TAIWAN

190312 LOT 120319

U10102500B

UNIVERSAL SCREW



10 X 2"1/2



U2 FASTENERS™
870 TUNGSTEN ST
THUNDER BAY, ON
P7B 6J3 CANADA

2,200 PCS
Approx. 26 lbs.



TIGHT STAR RECESS
NO STRIPPING



TAKES A T-25 U-BIT

BURROW POCKETS



COUNTERSINK HEAD

REAMER THREAD



INTERIOR / EXTERIOR USE

TAPPER POINT
NO PREDRILLING



PATENT PENDING
MADE IN TAIWAN

190312 LOT 120319

U10102500B

UNIVERSAL SCREW





10 X 2"3/4



U2 FASTENERS™
870 TUNGSTEN ST
THUNDER BAY, ON
P7B 6J3 CANADA

2,000 PCS
Approx. 26 lbs.



TIGHT STAR RECESS
NO STRIPPING



TAKES A T-25 U-BIT

BURROW POCKETS



COUNTERSINK HEAD

REAMER THREAD



INTERIOR / EXTERIOR USE

TAPPER POINT
NO PREDRILLING



PATENT PENDING
MADE IN TAIWAN

190312 LOT 120319

U10102750B

UNIVERSAL SCREW



10 X 2"3/4



U2 FASTENERS™
870 TUNGSTEN ST
THUNDER BAY, ON
P7B 6J3 CANADA

2,000 PCS
Approx. 26 lbs.



TIGHT STAR RECESS
NO STRIPPING



TAKES A T-25 U-BIT

BURROW POCKETS



COUNTERSINK HEAD

REAMER THREAD



INTERIOR / EXTERIOR USE

TAPPER POINT
NO PREDRILLING



PATENT PENDING
MADE IN TAIWAN

190312 LOT 120319

U10102750B

UNIVERSAL SCREW





10 X 3"1/8



U2 FASTENERS™
870 TUNGSTEN ST
THUNDER BAY, ON
P7B 6J3 CANADA

1,500 PCS
Approx. 21 lbs.



TIGHT STAR RECESS
NO STRIPPING



TAKES A T-25 U-BIT

BURROW POCKETS



COUNTERSINK HEAD

REAMER THREAD



INTERIOR / EXTERIOR USE

TAPPER POINT
NO PREDRILLING



PATENT PENDING
MADE IN TAIWAN

190312 LOT 120319

U10103125B

UNIVERSAL SCREW



10 X 3"1/8



U2 FASTENERS™
870 TUNGSTEN ST
THUNDER BAY, ON
P7B 6J3 CANADA

1,500 PCS
Approx. 21 lbs.



TIGHT STAR RECESS
NO STRIPPING



TAKES A T-25 U-BIT

BURROW POCKETS



COUNTERSINK HEAD

REAMER THREAD



INTERIOR / EXTERIOR USE

TAPPER POINT
NO PREDRILLING



PATENT PENDING
MADE IN TAIWAN

190312 LOT 120319

U10103125B

UNIVERSAL SCREW





10 X 3"1/2



U2 FASTENERS™
870 TUNGSTEN ST
THUNDER BAY, ON
P7B 6J3 CANADA

1,200 PCS
Approx. 19 lbs.



TIGHT STAR RECESS
NO STRIPPING



TAKES A T-25 U-BIT

BURROW POCKETS



COUNTERSINK HEAD

REAMER THREAD



INTERIOR / EXTERIOR USE

TAPPER POINT
NO PREDRILLING



PATENT PENDING
MADE IN TAIWAN

190312 LOT 120319

U10103500B

UNIVERSAL SCREW



10 X 3"1/2



U2 FASTENERS™
870 TUNGSTEN ST
THUNDER BAY, ON
P7B 6J3 CANADA

1,200 PCS
Approx. 19 lbs.



TIGHT STAR RECESS
NO STRIPPING



TAKES A T-25 U-BIT

BURROW POCKETS



COUNTERSINK HEAD

REAMER THREAD



INTERIOR / EXTERIOR USE

TAPPER POINT
NO PREDRILLING



PATENT PENDING
MADE IN TAIWAN

190312 LOT 120319

U10103500B

UNIVERSAL SCREW





10 X 4"



U2 FASTENERS™
870 TUNGSTEN ST
THUNDER BAY, ON
P7B 6J3 CANADA

1,000 PCS
Approx. 18 lbs.



TIGHT STAR RECESS
NO STRIPPING



TAKES A T-25 U-BIT

BURROW POCKETS



COUNTERSINK HEAD

REAMER THREAD



INTERIOR / EXTERIOR USE

TAPPER POINT
NO PREDRILLING



PATENT PENDING
MADE IN TAIWAN

190312 LOT 120319

U10104000B

UNIVERSAL SCREW



10 X 4"



U2 FASTENERS™
870 TUNGSTEN ST
THUNDER BAY, ON
P7B 6J3 CANADA

1,000 PCS
Approx. 18 lbs.



TIGHT STAR RECESS
NO STRIPPING



TAKES A T-25 U-BIT

BURROW POCKETS



COUNTERSINK HEAD

REAMER THREAD



INTERIOR / EXTERIOR USE

TAPPER POINT
NO PREDRILLING



PATENT PENDING
MADE IN TAIWAN

190312 LOT 120319

U10104000B

UNIVERSAL SCREW





10 X 4"1/2



U2 FASTENERS™
870 TUNGSTEN ST
THUNDER BAY, ON
P7B 6J3 CANADA

800 PCS

Approx. 16 lbs.



TIGHT STAR RECESS
NO STRIPPING



TAKES A T-25 U-BIT

BURROW POCKETS



COUNTERSINK HEAD

REAMER THREAD



INTERIOR / EXTERIOR USE

TAPPER POINT
NO PREDRILLING



PATENT PENDING
MADE IN TAIWAN

190312 LOT 120319

U10104500B

UNIVERSAL SCREW



10 X 4"1/2



U2 FASTENERS™
870 TUNGSTEN ST
THUNDER BAY, ON
P7B 6J3 CANADA

800 PCS

Approx. 16 lbs.



TIGHT STAR RECESS
NO STRIPPING



TAKES A T-25 U-BIT

BURROW POCKETS



COUNTERSINK HEAD

REAMER THREAD



INTERIOR / EXTERIOR USE

TAPPER POINT
NO PREDRILLING



PATENT PENDING
MADE IN TAIWAN

190312 LOT 120319

U10104500B

UNIVERSAL SCREW





12 X 3"1/2



U2 FASTENERS™
870 TUNGSTEN ST
THUNDER BAY, ON
P7B 6J3 CANADA

1,200 PCS
Approx. 28 lbs.



TIGHT STAR RECESS
NO STRIPPING



TAKES A T-25 U-BIT

BURROW POCKETS



COUNTERSINK HEAD

L- SHAPED CUTTING
TEETH



INTERIOR / EXTERIOR USE

TAPPER POINT
NO PREDRILLING



PATENT PENDING
MADE IN TAIWAN

190312 LOT 120319

U12103500B

UNIVERSAL SCREW



12 X 3"1/2



U2 FASTENERS™
870 TUNGSTEN ST
THUNDER BAY, ON
P7B 6J3 CANADA

1,200 PCS
Approx. 28 lbs.



TIGHT STAR RECESS
NO STRIPPING



TAKES A T-25 U-BIT

BURROW POCKETS



COUNTERSINK HEAD

L- SHAPED CUTTING
TEETH



INTERIOR / EXTERIOR USE

TAPPER POINT
NO PREDRILLING



PATENT PENDING
MADE IN TAIWAN

190312 LOT 120319

U12103500B

UNIVERSAL SCREW





12 X 5"



U2 FASTENERS™
870 TUNGSTEN ST
THUNDER BAY, ON
P7B 6J3 CANADA

500 PCS
Approx. 16 lbs.



TIGHT STAR RECESS
NO STRIPPING



TAKES A T-25 U-BIT

BURROW POCKETS



COUNTERSINK HEAD

REAMER THREAD



INTERIOR / EXTERIOR USE

TAPPER POINT
NO PREDRILLING



PATENT PENDING
MADE IN TAIWAN

190312 LOT 120319

U12105000B

UNIVERSAL SCREW



12 X 5"



U2 FASTENERS™
870 TUNGSTEN ST
THUNDER BAY, ON
P7B 6J3 CANADA

500 PCS
Approx. 16 lbs.



TIGHT STAR RECESS
NO STRIPPING



TAKES A T-25 U-BIT

BURROW POCKETS



COUNTERSINK HEAD

REAMER THREAD



INTERIOR / EXTERIOR USE

TAPPER POINT
NO PREDRILLING



PATENT PENDING
MADE IN TAIWAN

190312 LOT 120319

U12105000B

UNIVERSAL SCREW





12 X 6"



U2 FASTENERS™
870 TUNGSTEN ST
THUNDER BAY, ON
P7B 6J3 CANADA

500 PCS

Approx. 19 lbs.



TIGHT STAR RECESS
NO STRIPPING



TAKES A T-25 U-BIT

BURROW POCKETS



COUNTERSINK HEAD

REAMER THREAD



INTERIOR / EXTERIOR USE

TAPPER POINT
NO PREDRILLING



PATENT PENDING
MADE IN TAIWAN

190312 LOT 120319

U12106000B

UNIVERSAL SCREW



12 X 6"



U2 FASTENERS™
870 TUNGSTEN ST
THUNDER BAY, ON
P7B 6J3 CANADA

500 PCS

Approx. 19 lbs.



TIGHT STAR RECESS
NO STRIPPING



TAKES A T-25 U-BIT

BURROW POCKETS



COUNTERSINK HEAD

REAMER THREAD



INTERIOR / EXTERIOR USE

TAPPER POINT
NO PREDRILLING



PATENT PENDING
MADE IN TAIWAN

190312 LOT 120319

U12106000B

UNIVERSAL SCREW





12 X 7"



U2 FASTENERS™
870 TUNGSTEN ST
THUNDER BAY, ON
P7B 6J3 CANADA

300 PCS
Approx. 13 lbs.



TIGHT STAR RECESS
NO STRIPPING



TAKES A T-25 U-BIT

BURROW POCKETS



COUNTERSINK HEAD

REAMER THREAD



INTERIOR / EXTERIOR USE

TAPPER POINT
NO PREDRILLING



PATENT PENDING
MADE IN TAIWAN

190312 LOT 120319

U12107000B

UNIVERSAL SCREW



12 X 7"



U2 FASTENERS™
870 TUNGSTEN ST
THUNDER BAY, ON
P7B 6J3 CANADA

300 PCS
Approx. 13 lbs.



TIGHT STAR RECESS
NO STRIPPING



TAKES A T-25 U-BIT

BURROW POCKETS



COUNTERSINK HEAD

REAMER THREAD



INTERIOR / EXTERIOR USE

TAPPER POINT
NO PREDRILLING



PATENT PENDING
MADE IN TAIWAN

190312 LOT 120319

U12107000B

UNIVERSAL SCREW





12 X 8"



U2 FASTENERS™
870 TUNGSTEN ST
THUNDER BAY, ON
P7B 6J3 CANADA

300 PCS
Approx. 15 lbs.



TIGHT STAR RECESS
NO STRIPPING



TAKES A T-25 U-BIT

BURROW POCKETS



COUNTERSINK HEAD

REAMER THREAD



INTERIOR / EXTERIOR USE

TAPPER POINT
NO PREDRILLING



PATENT PENDING
MADE IN TAIWAN

190312 LOT 120319

U12108000B

UNIVERSAL SCREW



12 X 8"



U2 FASTENERS™
870 TUNGSTEN ST
THUNDER BAY, ON
P7B 6J3 CANADA

300 PCS
Approx. 15 lbs.



TIGHT STAR RECESS
NO STRIPPING



TAKES A T-25 U-BIT

BURROW POCKETS



COUNTERSINK HEAD

REAMER THREAD



INTERIOR / EXTERIOR USE

TAPPER POINT
NO PREDRILLING



PATENT PENDING
MADE IN TAIWAN

190312 LOT 120319

U12108000B

UNIVERSAL SCREW





12 X 10"



U2 FASTENERS™
870 TUNGSTEN ST
THUNDER BAY, ON
P7B 6J3 CANADA

300 PCS
Approx. 19 lbs.



TIGHT STAR RECESS
NO STRIPPING



TAKES A T-25 U-BIT

BURROW POCKETS



COUNTERSINK HEAD

REAMER THREAD



INTERIOR / EXTERIOR USE

TAPPER POINT
NO PREDRILLING



PATENT PENDING
MADE IN TAIWAN

190312 LOT 120319

U12110000B

UNIVERSAL SCREW



12 X 10"



U2 FASTENERS™
870 TUNGSTEN ST
THUNDER BAY, ON
P7B 6J3 CANADA

300 PCS
Approx. 19 lbs.



TIGHT STAR RECESS
NO STRIPPING



TAKES A T-25 U-BIT

BURROW POCKETS



COUNTERSINK HEAD

REAMER THREAD



INTERIOR / EXTERIOR USE

TAPPER POINT
NO PREDRILLING



PATENT PENDING
MADE IN TAIWAN

190312 LOT 120319

U12110000B

UNIVERSAL SCREW





12 X 12"



U2 FASTENERS™
870 TUNGSTEN ST
THUNDER BAY, ON
P7B 6J3 CANADA

300 PCS
Approx. 23 lbs.



TIGHT STAR RECESS
NO STRIPPING



TAKES A T-25 U-BIT

BURROW POCKETS



COUNTERSINK HEAD

REAMER THREAD



INTERIOR / EXTERIOR USE

TAPPER POINT
NO PREDRILLING



PATENT PENDING
MADE IN TAIWAN

190312 LOT 120319

U12112000B

UNIVERSAL SCREW



12 X 12"



U2 FASTENERS™
870 TUNGSTEN ST
THUNDER BAY, ON
P7B 6J3 CANADA

300 PCS
Approx. 23 lbs.



TIGHT STAR RECESS
NO STRIPPING



TAKES A T-25 U-BIT

BURROW POCKETS



COUNTERSINK HEAD

REAMER THREAD



INTERIOR / EXTERIOR USE

TAPPER POINT
NO PREDRILLING



PATENT PENDING
MADE IN TAIWAN

190312 LOT 120319

U12112000B

UNIVERSAL SCREW





1/4 X 2"1/2



U2 FASTENERS™
870 TUNGSTEN ST
THUNDER BAY, ON
P7B 6J3 CANADA



CROWN BIT

500 PCS
Approx. 15 lbs.



STAR RECESS



INCLUDES A CROWN BIT

FREE SPINNING SLEEVE



DOORS / WINDOWS / CEILINGS

REAMER THREAD



CHECK INSTALLATION INSTRUCTION

TYPE 17 POINT



PATENT # EP2331830B1
MADE IN TAIWAN

190312 LOT 120319

T00102500B

TOPSTAR



1/4 X 2"1/2



U2 FASTENERS™
870 TUNGSTEN ST
THUNDER BAY, ON
P7B 6J3 CANADA



CROWN BIT

500 PCS
Approx. 15 lbs.

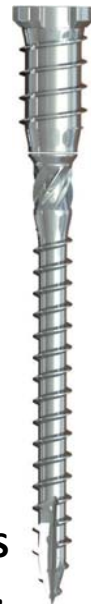

STAR RECESS



INCLUDES A CROWN BIT

FREE SPINNING SLEEVE



DOORS / WINDOWS / CEILINGS

REAMER THREAD



CHECK INSTALLATION INSTRUCTION

TYPE 17 POINT



PATENT # EP2331830B1
MADE IN TAIWAN

190312 LOT 120319

T00102500B

TOPSTAR





1/4 X 3"1/8



U2 FASTENERS™
870 TUNGSTEN ST
THUNDER BAY, ON
P7B 6J3 CANADA



CROWN BIT

500 PCS
Approx. 18 lbs.

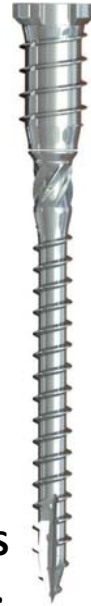

STAR RECESS



INCLUDES A CROWN BIT

FREE SPINNING SLEEVE



DOORS / WINDOWS / CEILINGS

REAMER THREAD



CHECK INSTALLATION INSTRUCTION

TYPE 17 POINT



PATENT # EP2331830B1
MADE IN TAIWAN

190312 LOT 120319

T00103125B

TOPSTAR



1/4 X 3"1/8



U2 FASTENERS™
870 TUNGSTEN ST
THUNDER BAY, ON
P7B 6J3 CANADA



CROWN BIT

500 PCS
Approx. 18 lbs.

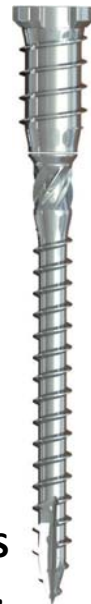

STAR RECESS



INCLUDES A CROWN BIT

FREE SPINNING SLEEVE



DOORS / WINDOWS / CEILINGS

REAMER THREAD



CHECK INSTALLATION INSTRUCTION

TYPE 17 POINT



PATENT # EP2331830B1
MADE IN TAIWAN

190312 LOT 120319

T00103125B

TOPSTAR





1/4 X 4"



U2 FASTENERS™
870 TUNGSTEN ST
THUNDER BAY, ON
P7B 6J3 CANADA



CROWN BIT

500 PCS
Approx. 23 lbs.

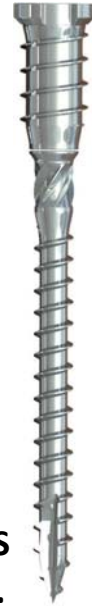

STAR RECESS



INCLUDES A CROWN BIT

FREE SPINNING SLEEVE



DOORS / WINDOWS / CEILINGS

REAMER THREAD



CHECK INSTALLATION INSTRUCTION

TYPE 17 POINT



PATENT # EP2331830B1
MADE IN TAIWAN

190312 LOT 120319

T00104000B

TOPSTAR



1/4 X 4"



U2 FASTENERS™
870 TUNGSTEN ST
THUNDER BAY, ON
P7B 6J3 CANADA



CROWN BIT

500 PCS
Approx. 23 lbs.

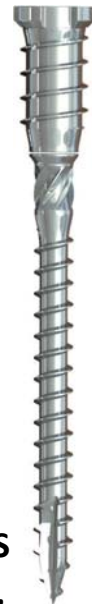

STAR RECESS



INCLUDES A CROWN BIT

FREE SPINNING SLEEVE



DOORS / WINDOWS / CEILINGS

REAMER THREAD



CHECK INSTALLATION INSTRUCTION

TYPE 17 POINT



PATENT # EP2331830B1
MADE IN TAIWAN

190312 LOT 120319

T00104000B

TOPSTAR



U² FASTENERS™

10 X 3"1/8



U2 FASTENERS™
870 TUNGSTEN ST
THUNDER BAY, ON
P7B 6J3 CANADA



800 PCS
Approx. 13 lbs.



STAR RECESS
NO STRIPPING



TAKES A T-25 BIT

WASHER HEAD



WINDOWS

L- SHAPED CUTTING
TEETH



INTERIOR / EXTERIOR USE

TEK POINT
NO PREDRILLING



MADE IN TAIWAN

190312 LOT 120319

V10103125B

VINYL EXTRUCTION S.



U² FASTENERS™

10 X 3"1/8



U2 FASTENERS™
870 TUNGSTEN ST
THUNDER BAY, ON
P7B 6J3 CANADA



800 PCS
Approx. 13 lbs.



STAR RECESS
NO STRIPPING



TAKES A T-25 BIT

WASHER HEAD



WINDOWS

L- SHAPED CUTTING
TEETH



INTERIOR / EXTERIOR USE

TEK POINT
NO PREDRILLING



MADE IN TAIWAN

190312 LOT 120319

V10103125B

VINYL EXTRUCTION S.





5/16 X 2"1/2



U2 FASTENERS™
870 TUNGSTEN ST
THUNDER BAY, ON
P7B 6J3 CANADA

1,000 PCS
Approx. 25 lbs.



STAR RECESS



TAKES A T- 30 U-BIT



FILLISTER HEAD

RAILING



FULL THREAD

STAINLESS STEEL



TYPE 17 POINT

MADE IN TAIWAN

190312 LOT 120319

120102500B

RAILING SCREW



5/16 X 2"1/2



U2 FASTENERS™
870 TUNGSTEN ST
THUNDER BAY, ON
P7B 6J3 CANADA

1,000 PCS
Approx. 25 lbs.



STAR RECESS



TAKES A T- 30 U-BIT



FILLISTER HEAD

RAILING



FULL THREAD

STAINLESS STEEL



TYPE 17 POINT

MADE IN TAIWAN

190312 LOT 120319

120102500B

RAILING SCREW



U² FASTENERS™

5/16 X 2"1/2



U2 FASTENERS™
870 TUNGSTEN ST
THUNDER BAY, ON
P7B 6J3 CANADA



600 PCS
Approx. 16 lbs.



TIGHT STAR RECESS
NO STRIPPING



TAKES A T- 30 U-BIT



WASHER HEAD WITH
TALON GRIP

FRAMING



REAMER THREAD

TAPPER POINT
NO PREDRILLING



PATENT PENDING
MADE IN TAIWAN

190312 LOT 120319

220102500B

OILED CONST. SCREW



U² FASTENERS™

5/16 X 2"1/2



U2 FASTENERS™
870 TUNGSTEN ST
THUNDER BAY, ON
P7B 6J3 CANADA



600 PCS
Approx. 16 lbs.



TIGHT STAR RECESS
NO STRIPPING



TAKES A T- 30 U-BIT



WASHER HEAD WITH
TALON GRIP

FRAMING



REAMER THREAD

TAPPER POINT
NO PREDRILLING



PATENT PENDING
MADE IN TAIWAN

190312 LOT 120319

220102500B

OILED CONST. SCREW



U² FASTENERS™

5/16 X 3"1/2



U2 FASTENERS™
870 TUNGSTEN ST
THUNDER BAY, ON
P7B 6J3 CANADA



500 PCS
Approx. 18 lbs.



TIGHT STAR RECESS
NO STRIPPING

TAKES A T- 30 U-BIT

WASHER HEAD

FRAMING

L- SHAPED CUTTING
TEETH

INTERIOR / EXTERIOR USE

TAPPER POINT
NO PREDRILLING

PATENT PENDING
MADE IN TAIWAN



190312 LOT 120319

220102500B

FULLT.CONST. SCREW



U² FASTENERS™

5/16 X 3"1/2



U2 FASTENERS™
870 TUNGSTEN ST
THUNDER BAY, ON
P7B 6J3 CANADA



500 PCS
Approx. 18 lbs.



TIGHT STAR RECESS
NO STRIPPING

TAKES A T- 30 U-BIT

WASHER HEAD

FRAMING

L- SHAPED CUTTING
TEETH

INTERIOR / EXTERIOR USE

TAPPER POINT
NO PREDRILLING

PATENT PENDING
MADE IN TAIWAN



190312 LOT 120319

220102500B

FULLT.CONST. SCREW



U² FASTENERS™

5/16 X 3"1/2



U2 FASTENERS™
870 TUNGSTEN ST
THUNDER BAY, ON
P7B 6J3 CANADA



500 PCS
Approx. 18 lbs.



TIGHT STAR RECESS
NO STRIPPING

TAKES A T- 30 U-BIT

WASHER HEAD

FRAMING

L- SHAPED CUTTING
TEETH

STAINLESS STEEL

TAPPER POINT
NO PREDRILLING

PATENT PENDING
MADE IN TAIWAN



190312 LOT 120319

120102500B

FULLT.CONST. SCREW



U² FASTENERS™

5/16 X 3"1/2



U2 FASTENERS™
870 TUNGSTEN ST
THUNDER BAY, ON
P7B 6J3 CANADA



500 PCS
Approx. 18 lbs.



TIGHT STAR RECESS
NO STRIPPING

TAKES A T- 30 U-BIT

WASHER HEAD

FRAMING

L- SHAPED CUTTING
TEETH

STAINLESS STEEL

TAPPER POINT
NO PREDRILLING

PATENT PENDING
MADE IN TAIWAN



190312 LOT 120319

120102500B

FULLT.CONST. SCREW

